

MICROtrac

MICROPROCESSOR – BASED WATER TREATMENT CONTROLLER

Installation and Operation Manual



NOVA-TECH
INTERNATIONAL

800 Rockmead Dr Ste 102 • Houston, TX 77339-2496
Tel: (281) 359-8538 • Toll Free Tel: (866) 433-6682
Fax: (281) 359-0084 • Toll Free Fax: (866) 433-6684
sales@novatech-usa.com • www.novatech-usa.com



72-910-02
REV. L

www.novatech-usa.com

FAX Toll Free: 1-866-433-6684 or 1-281-359-0084

MICROtrac Warranty

Pulsafeeder, Inc. warrants MICROtrac control systems (including the conductivity sensor) of its manufacture to be free of defects in material or workmanship. Liability under this policy extends for 24 months from date of shipment. The manufacturer's liability is limited to repair or replacement of any failed equipment or part, which is proven defective in material or workmanship upon completion of the manufacturer's examination. This warranty does not include removal or installation costs and in no event shall the manufacturer's liability exceed the selling price of such equipment or part.

The manufacturer disclaims all liability for damage to its products through improper installation, maintenance, use, or attempts to operate such products beyond their functional capacity, intentionally or otherwise, or any unauthorized repair. The manufacturer is not responsible for consequential or other damages, injuries, or expense incurred through the use of its products.

The above warranty is in lieu of any other warranty, whether expressed or implied. The manufacturer makes no warranty of fitness or merchantability. No agent of ours is authorized to provide any warranty other than the above.

Table of Contents

1. INTRODUCTION	4
2. INSTALLATION.....	4
2.1 Controller Location	4
2.2 Sensor Installation.....	4
3. ELECTRICAL WIRING	6
3.1 Electrical Connections.....	6
4. SYSTEM OPERATION.....	9
4.1 Front Panel.....	9
4.2 System Functions.....	10
4.3 Controller Programming	11
4.3.1 Control Modes.....	11
4.3.2 Conductivity Set Point	13
4.4 Alarm Conditions	13
5. SENSOR CALIBRATION	14
6. FACTORY DEFAULT VALUES	14
7. SPECIFICATIONS.....	15
8. TROUBLE SHOOTING GUIDE	16
9. CONTROLLER MOUNTING DIMENSIONS	18

1. Introduction

Your microprocessor-based controller has been designed to monitor and control the conductivity of your process water. The controller energizes two relay outputs based on a bleed and feed mode of operation.

- When the conductivity measurement goes **above** the user defined set point, (2) two relays are energized until the conductivity goes **below** the set point minus the fixed differential value.



The feed relay will also de-energize when the user programmable feed limit time is reached.

- **Optional** - The feed control relay will energize based on a percentage of a 10 minute feed cycle.

Your controller may or may not have the following optional configurations:

Pigtails (pre-wired)

The controller is pre-wired with a power cord and drop down receptacles for plugging in control devices such as a solenoid valve or a metering pump.

Flow Switch

The controller is supplied with a flow switch that is installed into the process flow line to signal the controller that your system has water flowing. When there is a no flow state, the controller will not energize the outputs.

2. Installation

2.1 Controller Location

Select a mounting location convenient to grounded electrical and plumbing connections. Mount the controller on a wall or other vertical surface with adequate lighting at a comfortable level. Remove the four screws that retain the front panel and remove it, mounting passages are located in each of the four corners in the back of the enclosure (See page 15). Installation should comply with all national, state and local codes.



Avoid locations where the controller would be subjected to extreme cold or heat {less than 0°F (-17,8°C) or greater than 122°F (50°C)}, direct sunlight, vibration, vapors, liquid spills or EMI (electromagnetic interference; e.g., strong radio transmission and electric motors). The controller could be damaged and void the warranty!

2.2 Sensor Installation

The controller is supplied with a temperature compensated conductivity sensor (probe). Install the sensor at some point in your process where chemical and water are thoroughly mixed. If the sensor is to be placed in a tank or sump, ensure that it is installed so that the black shrink-wrapped part of the probe cable is not submerged. The probe should also be located in a position where adequate flow is going across and through the probe.

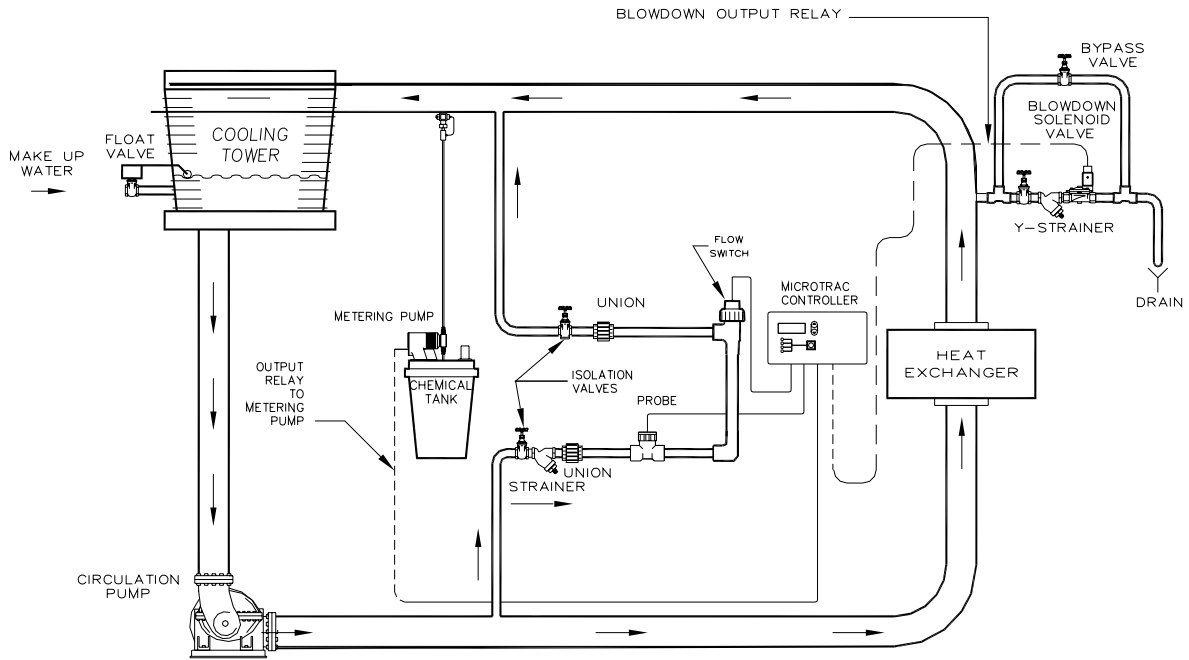

Typical Installation
Fig. 1

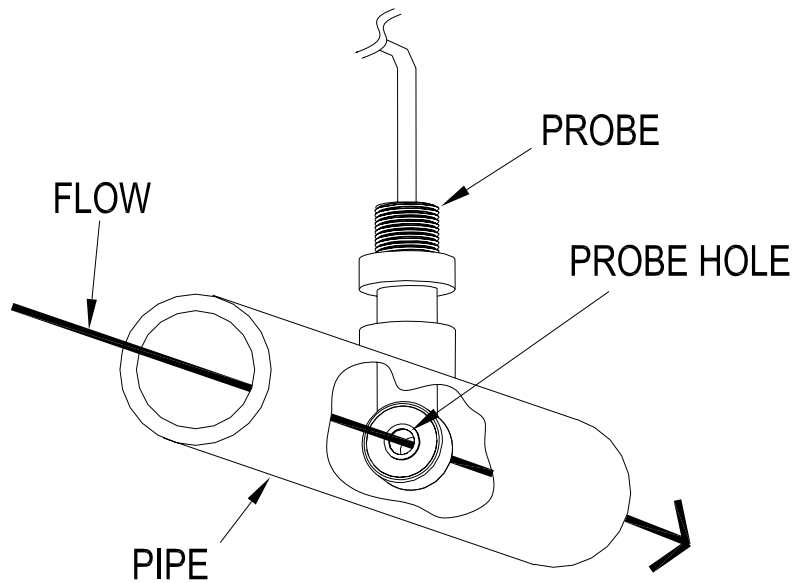

Probe Alignment
Fig. 2

 **NOTE** For maximum accuracy, make sure that the conductivity sensor is installed so the liquid stream passes straight through the round probe hole (see Fig.2).

Flow Sensor

If your controller is provided with a flow switch, install the flow switch so that flow enters into the bottom of the provided flow switch tee, and out of the side of the tee. The flow switch must always be installed in a vertical position so that the sensor wire is coming out of the top, and the internal (red) flow shuttle is able to rise when there is flow and drop when there is not flow. The flow switch is activated when 1 GPM (3.8 LPM) is going through it, and is deactivated when the flow drops below 1 GPM (3.8 LPM).

3. Electrical Wiring

The controller electronic circuitry is fuse protected. Use of a surge protector is strongly recommended!



CONTROLLER MUST BE WIRED IN ACCORDANCE WITH ALL APPLICABLE ELECTRICAL CODES.



The controller should be connected to a dedicated power branch (i.e., its own wiring, circuit breaker, etc.). For best results, the ground should be independent (true earth) not shared.



A switch or circuit-breaker, marked as the unit's disconnecting device should be included in the installation. It should be in close proximity to the unit and easily reached by the user.

Pre-wired controllers are supplied with 6 ft (1,8 m), 18 AWG (1,2 mm²) 3-wire grounded power cords and clearly marked 18 AWG (1,2 mm²) 3-wire grounded receptacle cords for all controlled line voltage outputs.

Controllers that are to use electrical conduit are factory pre-drilled with easily accessible connections for hard wiring of input and output power connections. Use only 16 AWG (1,5 mm²) or 18 AWG (1,2 mm²) wire for conduit power and load connections.

3.1 Electrical Connections

If your controller was not ordered as a pre-wired controller, hard wiring will be required. With the main power disconnected from the controller, loosen the four screws that retain the front panel of the controller and remove the front panel. There are five terminal block connectors inside the controller that will need to be wired.

Supply power

The controllers supply power is identified on the main PC board as location PL3 (refer to Fig. 3 on page 8). There are three connections identified on the board for this terminal block,

HOT (LINE), RTN (return or Neutral), and Ground. On some models, a power cord without a plug is provided.

Flow and Water meter inputs

These two inputs are located on connector PL2. This is where the two wires from the flow switch or water meter will connect. Polarity on this terminal block is not important.



If your controller is not equipped with a flow switch, there should be a jumper wire installed across PL2. (See Fig.3)

Dose/Feed (metering pump)

This control output is identified on the controller PC board as location PL4. The terminal block connections for PL4 are HOT (LINE), RTN (return or Neutral), and Ground.

This control output can drive pumping equipment based on the bleed and feed with limit timer mode. This output energizes when the programmed conductivity set point is exceeded. This output will de-energize when the conductivity reading falls below the set point minus the fixed set point differential (-5% of set point) or when the programmed feed limit time is exceeded.

Optional - This output energizes for a programmed percentage of a fixed 10 minute feed cycle.



The controller is fused at 5 amps maximum. Both output devices combined can not exceed 5 amps of current.

Bleed (solenoid valve)

This control output is identified on the controller PC board as location PL5. The terminal block connections for PL5 are HOT (LINE), RTN (return or Neutral), and Ground.

This control output will energize when the programmed conductivity set point is exceeded. This output will de-energize when the conductivity reading falls below the set point minus the fixed set point differential (-5% of set point).

Conductivity probe

The controller is supplied with one temperature compensated conductivity sensor. The sensor connects to PL1 of the controller PC board. Match the wire color from the probe with the text next to connector PL1.

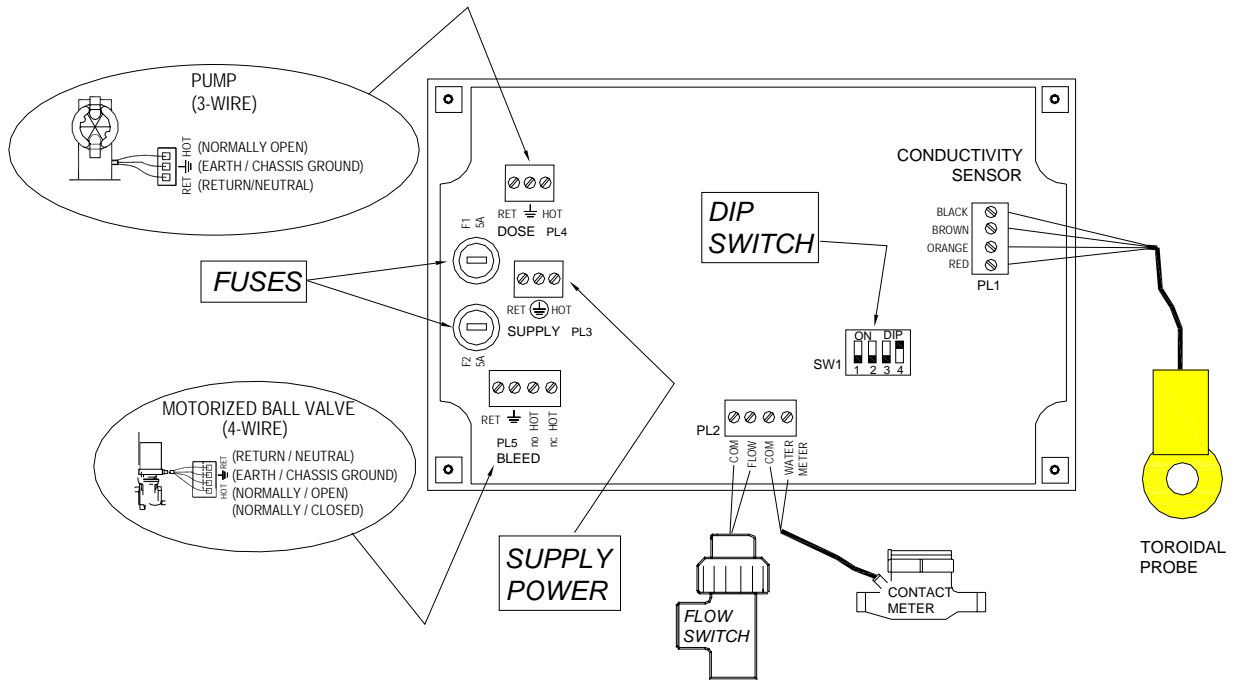

Wire Connections
Fig. 3

These connections are made using a green terminal block that uses screws to retain a wire inserted into the square openings as seen below. Using a small flat head screwdriver, loosen the screw enough to allow clearance for the wire, then insert the wire and tighten the screw securely.

NOTE **Controllers without an external flow detection switch must have a jumper installed across the flow switch input, PL2 (see Fig.3).**

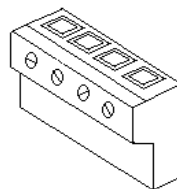

Terminal Block
Fig. 4

4. System Operation



BEFORE APPLYING POWER, INSURE THAT DEVICES BEING CONTROLLED BY THIS CONTROLLER ARE NOT IN A POSITION TO CAUSE HARM OR DAMAGE IF ENERGIZED UPON INITIAL START-UP.

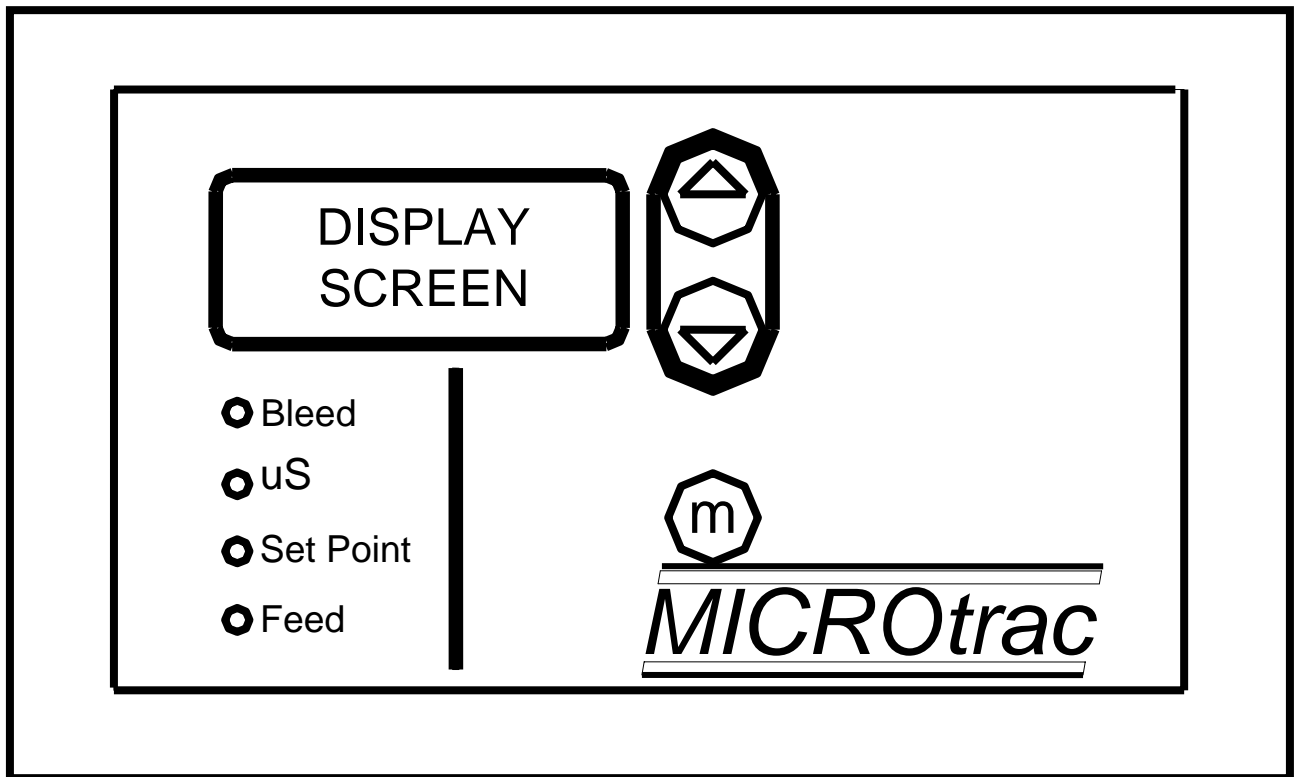

Front panel
Fig. 5

4.1 Front Panel

The front panel of the controller has a 4-digit LCD display, four LED indicators, and three pushbuttons that are used for programming and controller monitoring.

The LCD display is used to display the system conductivity as well as various system parameters during programming. The LED's are used to indicate what mode or function the controller is operating in. The **m** (MODE) button is used to enter programming mode and to view the controller parameters. The up and down arrows are used to change the controller settings once in programming mode.

4.2 System Functions

- Bleed** The bleed LED will light when the bleed relay is energized in normal operation or when the controller is displaying the bleed limit time setting. When in programming mode this LED will flash indicating it is okay to change the bleed limit time setting.
- uS** The uS LED will light when the controller is displaying the system conductivity reading. The controller displays this during normal operation or when there has been no button activity for 30 seconds. When calibrating the probe this LED will flash indicating it is okay to change the probe conductivity value.
- Set Point** The set point LED will light when the controller is displaying the conductivity set point. The set point is the conductivity value that will energize the Bleed and Dose relays. When in programming mode this LED will flash indicating it is okay to change the set point setting.
- Feed** This LED will light when the “Dose” or feed relay is energized. When in programming mode this LED will flash indicating it is okay to change the feed limit time setting.

Mode Selection

The controller’s mode of operation is selected by the switch settings of SW1 located on the PC board, see Fig. 3.

DIP SWITCH SETTINGS	1	2	3	4
LIMIT TIMER	*OFF	*OFF	*OFF	X
WATER METER	OFF	OFF	ON	X
% POST BLEED	OFF	ON	OFF	X
PERCENT TIMER	ON	OFF	OFF	X
FALLING SET POINT	X	X	X	OFF
RISING SET POINT	X	X	X	*ON

*** DEFAULT SETTING – limit timer with a rising set point.**

4.3 Controller Programming

Press the Mode button to advance to the setting to be changed indicated by the function's LED. To enter programming mode press and hold the Mode [m] button for five seconds. The function's LED will begin to flash when the programming mode has been activated. Use the [Up]/[Down] buttons to modify the programmable parameters.



During programming normal controller operation is suspended. If no keys are pressed for 30 seconds the controller will exit programming mode and return to normal operation.

4.3.1 Control Modes

Listed below are the different control modes of the MicroTrac controller. Each control mode uses simple parameters for user modifications.

- **Limit Timer** - *This control mode causes the Bleed and Feed output to energize when the conductivity exceeds the Conductivity setpoint. The Bleed and Feed limit timers can be activated to prevent over-feeding of chemicals.*

LED	Range	Function
BLEED	0-08:00 hh:mm	Optional limit timer. Set this value to the maximum amount of time a Bleed cycle should take before going into an alarm condition. Leaving this timer set to 0 disables this function. The time value is adjusted in 15 minute increments.
uS	1-9,999	This shows the current conductivity value.
Set Point	1-9,999	Conductivity Setpoint. Set this value to the maximum conductivity value before the Bleed output energizes.
Feed	0-8:00 hh:mm	Optional limit timer. Set this value to the maximum amount of time the Feed output should energize before going into an alarm condition. Once this timer expires the Feed output will de-energize. The time value is adjusted in 15 minute increments.

- **Water Meter** – *This control mode causes the Feed output to energize when a programmed number of pulses are detected on the water meter input terminal.*

LED	Range	Function
BLEED	0-08:00 hh:mm	Optional limit timer. Set this value to the maximum amount of time a Bleed cycle should take before going into an alarm condition. Leaving this timer set to 0 disables this function. The time value is adjusted in 15 minute increments.
uS	1-9,999	This shows the current conductivity value.
Set Point	1-9,999	Conductivity Setpoint. Set this value to the maximum conductivity value

		before the Bleed output energizes.
Feed	Counts + Time	Counts – Set this value to the number of water meter input pulses needed before the Feed cycle begins. Range = 1-9,999. Time – Set this value to the amount of time the Feed output should energize when the programmed number of water meter input pulses have been detected. Range = 0-59:55, MM:SS. The time value is adjusted in 5 second increments.

- **% Post Bleed** – *This control mode causes the Feed output to energize following a Bleed cycle. The amount of time the Feed output stays energized is based on the programmed percentage of the prior Bleed cycle.*

LED	Range	Function
BLEED	0-08:00 hh:mm	Optional limit timer. Set this value to the maximum amount of time a Bleed cycle should take before going into an alarm condition. Leaving this timer set to 0 disables this function. The time value is adjusted in 15 minute increments.
uS	1-9,999	This shows the current conductivity value.
Set Point	1-9,999	Conductivity Setpoint. Set this value to the maximum conductivity value before the Bleed output energizes.
Feed	Percent + Time	Percentage – Set this value to a percentage of the prior Bleed cycle the Feed output should energize. Example: Percent=25, Bleed cycle took 14 minutes, the Feed output would energize for 25% of 14 minutes, or 3.5 minutes. Range = 0-100. Time – Optional limit timer. Set this value to the maximum amount of time the Feed output should energize before going into an alarm condition. Once this timer expires the Feed output will de-energize. Range = 0-08:00, hh:mm. The time value is adjusted in 15 minute increments.

- **Percent Timer** – *This control mode causes the Feed output to energize based on a percentage of a fixed time cycle. The cycle time is base on a fixed 10-minute cycle. Once the 10-minute cycle completes the cycle will be restarted again.*

LED	Range	Function
BLEED	0-08:00 hh:mm	Optional limit timer. Set this value to the maximum amount of time a Bleed cycle should take before going into an alarm condition. Leaving this timer set to 0 disables this function.
uS	1-9,999	This shows the current conductivity value.
Set Point	1-9,999	Conductivity Setpoint. Set this value to the maximum conductivity value before the Bleed output energizes.
Feed	Percent	Percentage – Set this value to a percentage of the 10-minute cycle time. Example: Percent=20, cycle time of 10 minutes, the Feed output would energize for 20% of 10 minutes, or 2 minutes. Range = 0-100.

4.3.2 Conductivity Set Point

Set this value to the highest conductivity point the controller will allow before a bleed and feed cycle begins. When the system conductivity reaches this set point the bleed and feed control outputs will energize. When the system conductivity falls to the conductivity set point minus 5% the bleed and feed cycle will terminate and the control outputs will de-energize.

The Conductivity Set Point can be changed with the [Up]/[Down] buttons once in programming mode. The maximum setting is 9999 uS/cm. To save the set point press the Mode [m] button.



The set point differential is fixed at 5% below the set point. For example, if the set point is set to 1000uS/cm the bleed and feed outputs will energize at 1000uS/cm and de-energize at 950uS/cm.

4.4 Alarm Conditions

Flow Alarm

With a loss of flow the two (red) LED's will flash and the display will read "Err Flo." The outputs will de-energize. This alarm will reset automatically with the resumption of flow.

Feed Limit Timer Alarm

When the Feed Limit time is exceeded the two red LED's and the blue LED will flash and the display will read "Err Lit" and the Feed relay will de-energize. This alarm is reset by: pressing the M (Mode) button, a flow cycle, or conductivity reaching the set point and differential.

Bleed Limit Timer Alarm

When the Bleed Limit time is exceeded the two red LED's and the green LED will flash and the display will read "Err Lit". This alarm is reset by: pressing the M (Mode) button, a flow cycle, or conductivity reaching the set point and differential. This will not de-energize the bleed relay, only reset the timer.

Bleed and Feed Limit Timer Alarm

When the Bleed and Feed Limit time is exceeded, all the LED's will flash and the display will read "Err Lit". This alarm is reset by pressing the M (Mode) button, a flow cycle, or conductivity reaching the set point and differential.



Bleed Limit Alarms: will not de-energize the Bleed relay.

Conductivity Over Range Alarm – (Rising Set Point)

If the conductivity is over 9,999uS/cm, all the LED's will flash and the display will read "Err 9,999" and the Bleed relay will remain on. This alarm is reset by pressing the M (Mode) button once the conductivity is within range.



Both Limit Timers will reset if the conductivity reading changes to above or below the set point and differential.

NOTE

5. Sensor Calibration

The controller is factory calibrated and requires no user adjustments. Some deviation in the reading may be expected when compared to a hand-held tester. However, if you wish to perform a calibration, follow this procedure:

1. Place the probe in the process that it will normally be installed in and allow flow across the probe for approximately 15 minutes. This will allow the probe temperature to equalize.
2. While the “uS” LED is steady press and hold the “m” mode button for five seconds until the controller flashes “Cal”. Release the “m” button.
3. The controller will now display the actual conductivity reading from the probe. Use the up and down buttons to change the reading until it matches your hand-held’s reading. If you press and hold the up or down buttons, the displayed value will change very quickly.
4. When finished press the “m” button once.



IMPORTANT! For optimum performance, make sure that the system conductivity is near the set point that you intend to operate the system.

NOTE

The calibration process is now complete.

6. Factory Default Values

Set point:	1500 μ S/cm
Bleed Limit timer:	00:00, HH:MM
Feed Limit timer:	00:00, HH:MM

7. Specifications

Controller	
Enclosure	NEMA 4X / IP66
Enclosure Dimensions	6.4 in. x 2.5 in. x 3.2 in. (163 x 64 x 82mm)
Power supply	120 or 220 VAC, 50/60 Hz.
Fuses	5A x 2
Display	LCD 0 - 9,999 $\mu\text{S}/\text{cm}$ range 1 $\mu\text{S}/\text{cm}$ resolution
Set Point range	0 - 9,999 $\mu\text{S}/\text{cm}$ range 1 $\mu\text{S}/\text{cm}$ increments
Set Point differential (Hysteresis)	Fixed 5% below the set point
Accuracy	+/- 2% of scale
Maximum Relay Output Current	120 VAC <ul style="list-style-type: none"> • 5A Resistive/General use • 4LRA/FLA, 1/10HP (motors) 220 VAC <ul style="list-style-type: none"> • 5A Resistive/General use • Not rated for motors

Probe	
Maximum temperature	122° F (50°C)
Temperature compensation range	32°F – 122°F (0° – 50°C)
Maximum pressure	125 PSI (8.6 BAR)
Probe type	Toroidal
Maximum cable length	98.4 Feet (30 Meters)
Materials of construction	Polypropylene
Thread size	.5 in. Standard thread - excludes tee and reducer bushing
Maximum outside diameter	1.5 in. (38 mm)- Excludes Tee and Reducer

Flow Switch	
Maximum temperature	127°F (52°C)
Maximum pressure	125 PSI (8,6 BAR)
Activate flow rate	Approximately 1 GPM (3,785 LPM)
Materials of construction	PVC and Glass filled Polypropylene



Flow Switch
Fig. 6



Conductivity probe with tee
Fig. 7

8. Trouble Shooting Guide

Symptom	Probable Cause	Possible Solution
Controller does not power up	No power supplied to controller	Insure that correct voltage is supplied to controller.
	Fuse is blown	Check circuit breaker supplying power to the controller.
	Probe wiring incorrect	check/replace fuse (<i>see Figure 3, Page 8</i>)
Controller powers up but displays "Flo Err"	Insufficient flow through flow switch	Check probe wiring (<i>see Figure 3, Page 8</i>)
	Flow switch not connected.	Ensure there is enough of a pressure differential from the inlet of the flow switch and the outlet to achieve at least 1 GPM (3.8 LPM) of flow
	Flow switch stuck.	Check flow switch connections (<i>see Figure 3, Page 8</i>)
	Flow switch cap bad.	Clean flow sensor
	Bad shuttle.	Check for wire integrity or replace flow cap.
		Replace shuttle
Controller powers up but displays "Cond Err"	Loose conductivity probe wire	Check probe wiring (<i>See Figure 3, Page 8</i>)
	Bad Conductivity probe	Replace probe.
Controller powers up but displays "Lit Err"	User set Limit timer has expired	Reset limit by pressing the M (Mode) button

Controller powers up but displays "9999 Err"	Conductivity over maximum range	Reduce the system conductivity.
		Reset limit by pressing the M (Mode) button when conductivity is back in range.
	Probe wiring incorrect	Check probe wiring (<i>see Figure 3, Page8</i>)
	Bad Conductivity probe	Replace sensor
Conductivity reading on controller does not match a hand-held reading.	Conductivity reading is within specification.	Due to variations in hand-held meters, conductivity standard solutions, temperature compensation, and the controller's accuracy of +/- 2% of scale, the reading on the controller may not match that of your hand-held tester.

9. Controller Mounting Dimensions

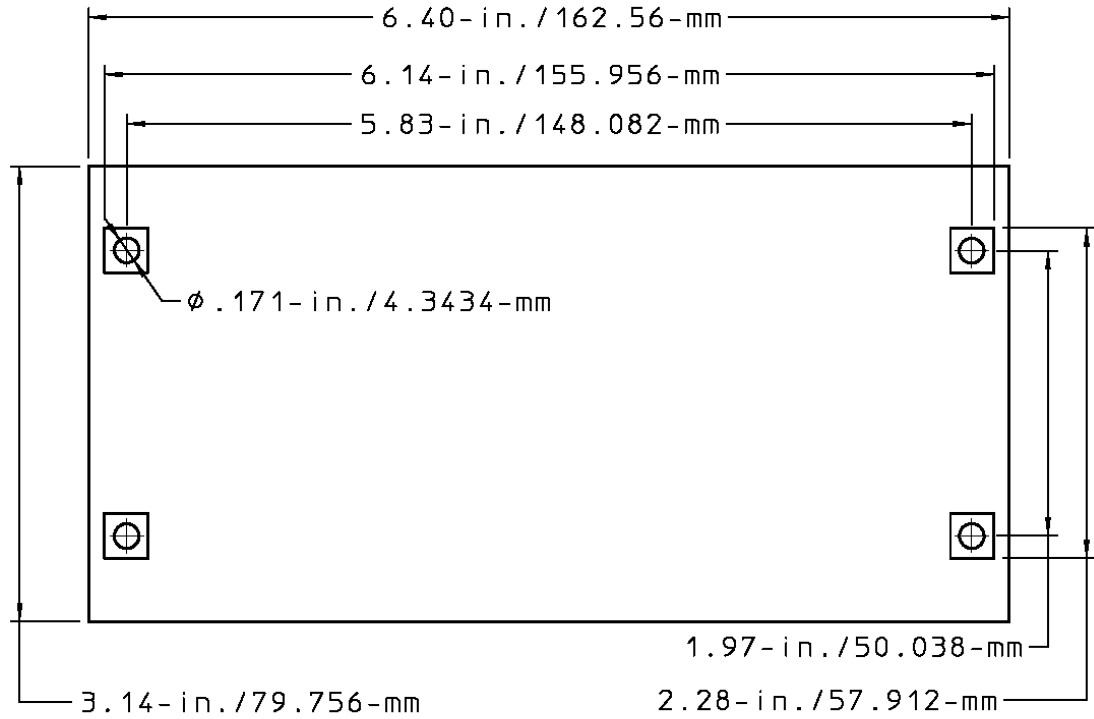

MICROTRAC FOOTPRINT

Fig. 8

MICROtrac Factory Service Policy

Your MICROtrac controller is a state of the art microprocessor based controller. If you are experiencing a problem with your Microtrac controller, first consult the troubleshooting guide in this manual. If the problem cannot be resolved contact Technical Services for assistance.

PULSAFEEDER INC. (SPO)
27101 AIRPORT ROAD
PUNTA GORDA, FL 33982
941-575-3800

Trained technicians are available to help diagnose your controller or process problems.

All returns require a Return Authorization number to be issued by Pulsafeeder. Parts purchased to correct a warranty issue may be credited after an examination of original parts by Pulsafeeder. Warranty parts returned as defective which test good will be sent back freight collect. No credit will be issued on any replacement electronic parts.

Any modifications or out-of-warranty repairs will be subject to associate parts and labor costs.

EC Declaration of Conformity

We, Pulsafeeder Inc., declare under sole responsibility that Microtrac equipment to which this declaration relates is in sole conformity with relevant sections of the applicable EC standards and other normative documents listed on this document. If changes are made to the product which is covered by this declaration of conformity, the declaration of conformity is no longer valid.

- Radiated emissions EN 61326
- Harmonic current emissions (EN 61000-3-2-1995+A14:1998)
- Voltage fluctuations and flicker (EN 61000-3-3: 1995)
- Electrostatic Discharge Immunity Test (EN 61000-4-2:95)
- Radiated immunity test (EN 61000-4-3:96)
- Electrical Fast Transient/Burst Immunity Test (EN 61000-4-4:95)
- Surge Immunity Test (EN 61000-4-5:95)
- Immunity to conducted disturbances (EN 61000-4-6:96)
- Power Frequency Magnetic Field Immunity Test (EN 61000-4-8:93)
- Voltage Dips, Short Interruptions and Voltage Variations Immunity Tests (EN61000-4-11:1994)
- 2002/96/EG (WEEE) compliant
- RoHS compliant

The logo for PULSAFEEDER features a stylized, bold, black icon on the left that resembles a gear or a series of interlocking shapes. To the right of this icon, the word "PULSAFEEDER" is written in a large, bold, black, sans-serif font. The letters are closely spaced and have a slightly italicized appearance.