

Instruction Manual

pH 11 & pH 110

Hand-held pH / mV / Temperature / RS 232 Meter



OAKTON[®]

EUTECH
INSTRUMENTS
Technology Made Easy...

68X361301

Rev. 2 - 11/03



Preface

This manual serves to explain the use of the hand-held series meters. The models covered are the pH 11 and the pH 110 hand-held meters.

The manual functions in two ways, firstly as a step by step guide to help the user operate the meter. Secondly, it serves as a handy reference guide.

This instruction manual is written to cover as many anticipated applications of the pH meters as possible. If there are doubts in the use of the pH 11/110 meters, do not hesitate to contact the nearest Authorised Distributor.

It is recommended that all operators should read this manual prior to working with this instrument. Eutech Instruments / Oakton Instruments cannot accept any responsibility for damage or malfunction to the meter caused by improper use of the instrument.

The information presented in this manual is subject to change without notice as improvements are made, and does not represent a commitment on the part of Eutech Instruments Pte Ltd / Oakton Instruments.

Copyright © 2003 All rights reserved.

Eutech Instruments Pte Ltd

Oakton Instruments

Rev. 2 - 11/03

TABLE OF CONTENTS

1	INTRODUCTION.....	1
2	DISPLAY & KEYPAD FUNCTIONS.....	2
2.1	DISPLAY.....	2
2.2	KEYPAD.....	3
3	PREPARATION	5
3.1	INSERTING THE BATTERIES.....	5
3.2	CONNECTING THE pH ELECTRODE TEMPERATURE PROBE & ELECTRODE HOLDER.....	6
3.2.1	<i>To connect pH, ORP or ISE electrode.....</i>	6
3.2.2	<i>To connect the temperature probe:.....</i>	7
3.2.3	<i>Attaching the Electrode Holder to the Meter.....</i>	7
3.2.4	<i>To attach a second electrode holder:.....</i>	7
3.2.5	<i>Insert the electrode into the holder.....</i>	8
3.3	CONNECTING THE AC/DC ADAPTER.....	9
3.4	CONNECTING THE RS232C CABLE (ONLY FOR pH 110).....	9
3.4.1	<i>RS232C Configuration.....</i>	10
4	CALIBRATION.....	11
4.1	IMPORTANT INFORMATION ON METER CALIBRATION.....	11
4.2	PREPARING THE METER FOR CALIBRATION.....	11
4.2.1	<i>pH 11 meter calibration.....</i>	12
4.2.2	<i>pH 110 meter calibration.....</i>	12
4.3	pH CALIBRATION WITH ATC.....	13
4.4	mV CALIBRATION (OFFSET) (ONLY FOR pH 110).....	15
4.5	TEMPERATURE CALIBRATION.....	16
5	MEASUREMENT.....	17
5.1	AUTOMATIC TEMPERATURE COMPENSATION.....	17
5.2	MANUAL TEMPERATURE COMPENSATION.....	18
5.3	TAKING MEASUREMENTS.....	19
5.3.1	<i>Taking measurements with READY indicator selected on.....</i>	19
5.3.2	<i>Taking measurements with the AUTO HOLD feature selected on.....</i>	19
6	HOLD FUNCTION.....	20
7	MEMORY FUNCTION.....	21
7.1	MEMORY INPUT.....	21
7.2	MEMORY RECALL.....	22
8	PRINT FUNCTION (ONLY FOR PH 110).....	23
8.1	USING pH 110 METER WITH PRINTER OR COMPUTER.....	23
8.2	SENDING DATA TO COMPUTER OR PRINTER.....	24
8.2.1	<i>Print Current Data Manually.....</i>	25
8.2.2	<i>Print Data on Timed Interval.....</i>	25
8.2.3	<i>Print Data from Stored Memory.....</i>	26
9	ADVANCED SETUP FUNCTIONS.....	29
9.1	ADVANCED SETUP MODE OVERVIEW.....	31
9.1.1	<i>pH Setup mode.....</i>	31
9.1.2	<i>mV Setup mode.....</i>	32
9.2	P1.0 : UNIT CONFIGURATION.....	33
9.2.1	<i>P1.1: READY Indicator and Auto Hold function.....</i>	34
9.2.2	<i>P1.2: Select Calibration Buffer Options.....</i>	35
9.2.3	<i>P1.3 Select Number of pH Calibration Points.....</i>	36
9.2.4	<i>P1.4 Select °C or °F Temperature Units.....</i>	37

9.3	P2.0: VIEWING PREVIOUS CALIBRATION DATA	38
9.4	P3.0: VIEW ELECTRODE DATA.....	39
9.4.1	View pH Electrode Offset and Slope	39
9.4.2	View mV Offset (Only for pH 110)	40
9.5	P4.0 : AUTO-OFF.....	41
9.6	P5.0 : RESET TO FACTORY DEFAULT	42
9.6.1	Calibration Reset	42
9.6.2	User Reset	43
9.7	P 6.0: MEMORY CLEAR (CLR)	44
10	CYBERCOMM PORTABLE DAS (ONLY FOR PH 110)	45
10.1	SYSTEM REQUIREMENTS.....	45
10.2	LOADING CYBERCOMM PORTABLE DAS.....	45
10.3	RUNNING CYBERCOMM PORTABLE	52
10.3.1	Buttons & Check-Box.....	53
10.3.2	Menu.....	53
10.3.3	Communication Settings.....	54
10.4	CAPTURING AND PRINTING DATA INTO COMPUTER USING DATA ACQUISITION	55
10.5	TROUBLE-SHOOTING GUIDE.....	56
11	ELECTRODE CARE	57
11.1	ELECTRODE MAINTENANCE.....	57
11.1.1	Storage	57
11.1.2	After Use	57
11.1.3	Electrolyte Replacement (for refillable electrodes only).....	57
11.2	ELECTRODE CLEANING	58
11.3	ELECTRODE ACTIVATION.....	58
11.4	REJUVENATION PROCEDURE.....	59
12	ERROR MESSAGES.....	60
13	TROUBLE-SHOOTING	61
14	INFORMATION ON PH MEASUREMENT & ELECTRODE	62
14.1	PH MEASUREMENTS	62
14.1.1	Liquid Junction Potential	62
14.1.2	Asymmetry Potential	62
14.1.3	pH and Temperature	63
14.2	USE OF STANDARD PH BUFFERS	63
14.3	STANDARD PH BUFFERS	64
15	LIST OF ACCESSORIES.....	65
15.1	REPLACEMENT METER AND METER ACCESSORIES.....	65
15.2	OAKTON INSTRUMENTS	66
15.3	CALIBRATION SOLUTIONS.....	67
16	FACTORY DEFAULT SETTINGS.....	68
16.1	PH 11 FACTORY DEFAULT SETTINGS	68
16.2	PH 110 FACTORY DEFAULT SETTINGS	69
17	SPECIFICATIONS.....	70
18	WARRANTY.....	71
19	RETURN OF ITEMS	71

1 INTRODUCTION

Thank you for selecting the pH 11/110 meter. These meters are microprocessor-based instruments and are designed to be handy, capable of allowing one-hand operation. Each has a large custom dual LCD for clear and easy reading. It is a unique and intelligent instrument that has the capability to cater to the preferences of the discerning individual. You have one of the two models:

- pH 11 meter
- pH 110 meter

Both meters have many user-friendly features – all of which are completely accessible through the splash-proof membrane keypad. Your meter includes a temperature probe, electrode holder, built-in meter stand and batteries. Eutech Instruments/ Oakton Instruments offer a wide selection of pH and ORP electrodes. Refer to Section 15 LIST OF ACCESSORIES on page 65 for more information.

The basic model is the pH 11 which is capable of measuring pH, Temperature, and millivolt (mV).

The deluxe model is the pH 110 which measures pH, Temperature, millivolt (mV) and relative millivolt (Rel mV). It has many advanced features and allows you to customise the meter settings. It also has a RS232C port that allows the meter to be connected to a computer or a printer via a cable for transferring data.

For power requirements, you can either use 4 AAA-sized batteries or an AC/DC power adapter (sold separately).

Please read this manual thoroughly before operating your meter.

2 DISPLAY & KEYPAD FUNCTIONS

2.1 Display

The LCD has a primary and secondary display.

- The primary display shows the measured pH or mV values.
- The secondary display shows the measured temperature.

The display also shows error messages, keypad functions and program functions.

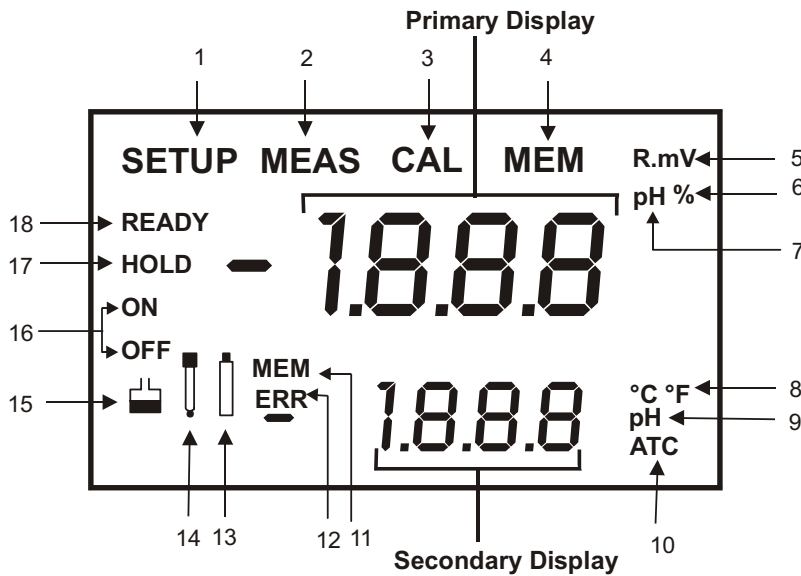









Figure 1: Active LCD screen

1. SETUP - Setup mode indicator	7. pH - pH indicator	13. - Low battery indicator
2. MEAS - Measurement mode indicator	8. °C°F - Temperature indicator	14. - Electrode indicator
3. CAL - Calibration indicator	9. pH - pH buffer selection indicator	15. - Calibration buffer indicator
4. MEM - Memory recall mode indicator	10. ATC - Automatic Temperature Compensation indicator	16. ON – READY/Auto HOLD set up enable indicator. OFF – READY set up disable indicator
5. R.mv - Relative millivolt (For pH 110 only)& millivolt indicator (For both model)	11. MEM - Memory location indicator	17. HOLD – Hold indicator
6. % - Percentage indicator	12 ERR - Error indicator	18. READY – Ready indicator

2.2 Keypad

A large membrane keypad makes the instrument easy to use. Each button, when pressed, has a corresponding graphic indicator on the LCD (Figure 2 on previous page). Some buttons have several functions depending on its mode of operation.

KEY	FUNCTION
	<ul style="list-style-type: none"> ON/OFF - Powers on and shuts off the meter. The meter will start in a measurement mode similar to the last measurement mode it is in before being switched off.
	<ul style="list-style-type: none"> CAL - Activates the pH or Relative mV calibration mode and when used with the MODE key, it activates the temperature calibration mode. MEAS - Allows return to measurement mode when canceling or terminating any operation.
	<ul style="list-style-type: none"> HOLD - Activates/Deactivates freezing of the measured reading while in measurement mode. ENTER - Confirms the calibration values in Calibration mode and the selection in SETUP and Print Function mode. Scroll through the memory location and the stored data during memory recall.
 	<ul style="list-style-type: none"> MI (Memory Input) - Captures the measured readings of the pH, Relative mV or mV with its corresponding temperature values and stores them in the memory. MR (Memory Recall) - Retrieves the stored data from memory. ▲ ▼ - Sets the calibration values during Relative mV or temperature calibration. Scrolls through each SETUP and its sub group menu. Scroll through Print Function menu and its parameters.
	<ul style="list-style-type: none"> SETUP - Activates the parameter setting menu to allow you to customise meter configuration, view calibration points and electrode offset data, select auto power off, reset meter, and clear memory.
	<ul style="list-style-type: none"> MODE - Selects the measurement parameter option between pH with temperature, Relative mV with temperature (only pH 110), and mV with temperature.
 (pH 110)	<ul style="list-style-type: none"> PRINT - Allows print of current measurement or stored data to either the printer or the computer.

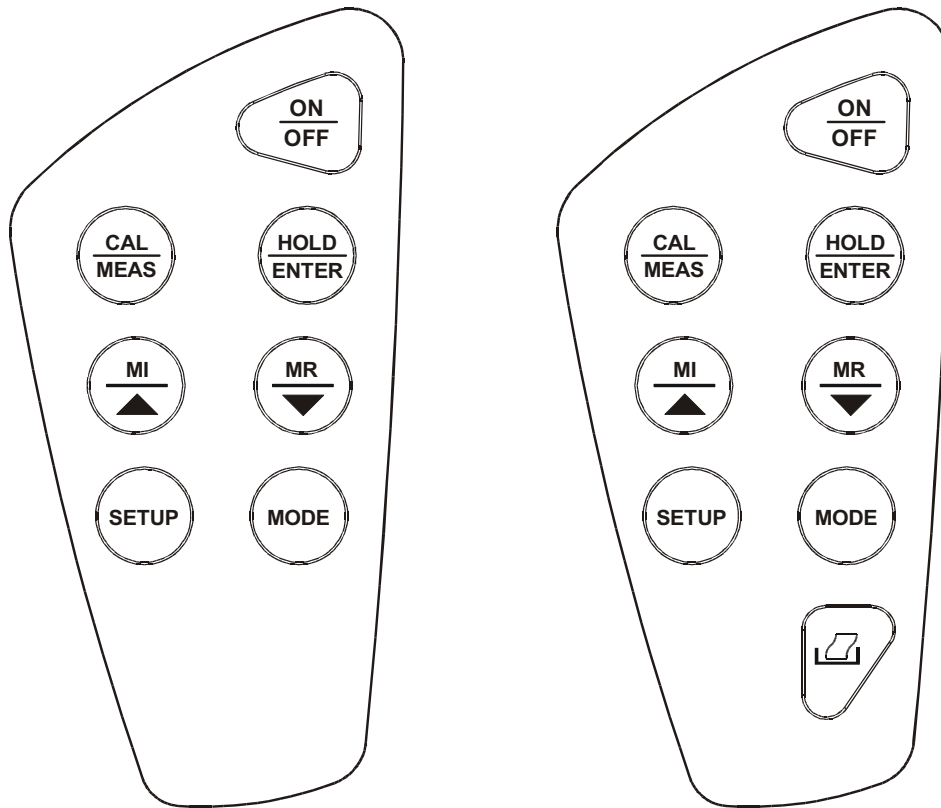

Keypad for pH 11 meter

Keypad for pH 110 meter

Figure 2: pH 11 and pH 110 keypads

3 PREPARATION

3.1 Inserting the Batteries

This meter is packaged with 4 “AAA” alkaline batteries required for operation. To insert the batteries into the meter, follow the procedure outlined below.

1. To open the battery compartment, press down the catch of the battery cover. See below.
2. Note the polarity and insert the batteries into the battery compartment correctly
3. Replace the battery cover into its original position, ensuring the catch is locked in position.

Your hand-held meter is now ready for operation.

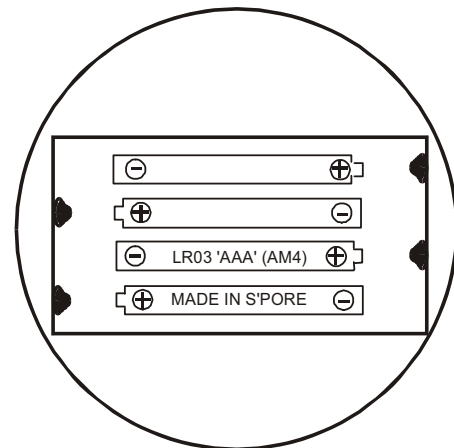
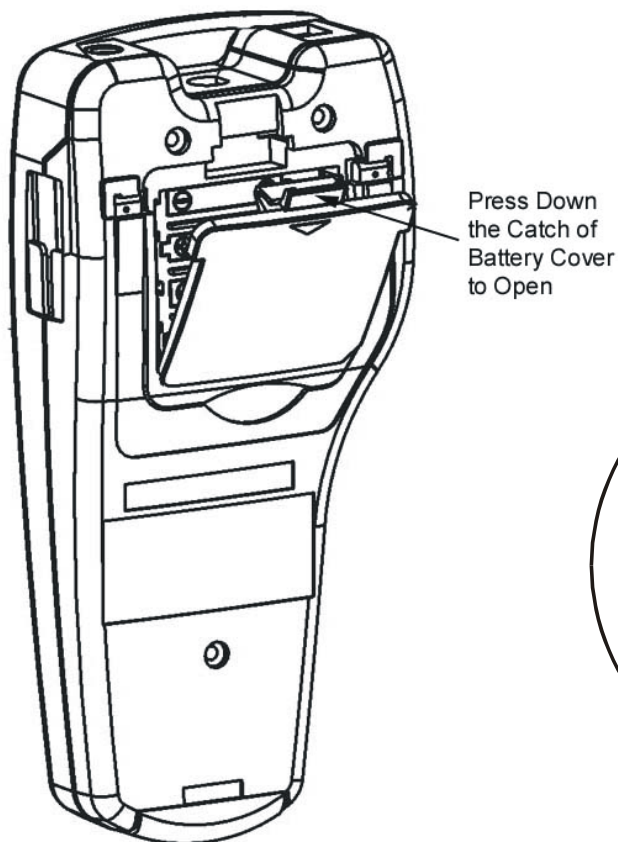

Figure 4: Note battery's polarity

Figure 3: Open Battery Cover

3.2 Connecting the pH Electrode Temperature Probe & Electrode Holder

The pH 11/110 meter uses any standard pH, ORP, or Ion Selective Electrode (ISE) with a BNC connector. For Automatic Temperature Compensation (ATC), this meter requires a temperature probe with a phono-jack connector.

NOTE: It is important that water does not get into the BNC connector. Also avoid touching the connector with soiled hands.

3.2.1 To connect pH, ORP or ISE electrode

1. Insert the BNC connector from the electrode over the BNC connector socket on the meter.
2. Make sure the slots of the connector are in line with the posts of the socket.
3. Slide the BNC connector of the electrode over (Figure 5).
4. Rotate the connector clockwise until it locks.
5. To remove electrode, push and rotate the connector counterclockwise.
6. While holding onto the metal part of the connector, pull it away from the meter.
7. Be careful not to use excessive force.

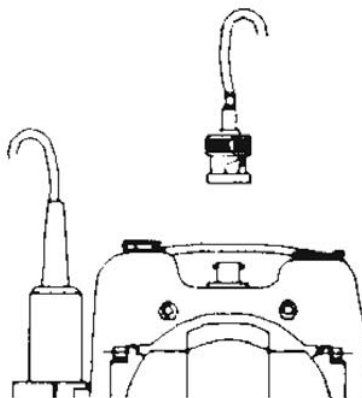

Figure 5: Insert the BNC connector from the electrode cable into the BNC socket on the meter.

CAUTION: Do not pull on the probe cord or the probe wires might disconnect.

Refer to section 15 LIST OF ACCESSORIES section on page 65 for information on temperature probe and other electrodes.

3.2.2 To connect the temperature probe:

The temperature probe (provided) uses a 2.5 mm phono jack to connect with the socket on the pH 11/110. Insert the jack fully into the socket (Figure 6).

Note: Calibrate your temperature probe when you replace the probe and when using a “3-in-One” combination pH and temperature probe. See section 4.5 - Temperature Calibration on page 16 for instructions.

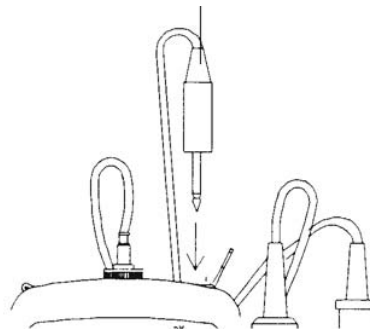

Figure 6: Insert temperature probe

3.2.3 Attaching the Electrode Holder to the Meter

The pH meter is designed to allow you to do a one hand operation for any measurement or calibration. For that purpose, two electrode holders are provided. They are designed for easy use and installation. Care must be taken to avoid use of excessive force in the process of attaching these components.

1. Locate the slot on the right-hand side of the meter.
2. Gently slide the flange of the holder into the slot on the meter. Make sure the holder is secured properly into the slot (Figure 7).
3. You can attach the electrode holder in different positions (Figure 9).

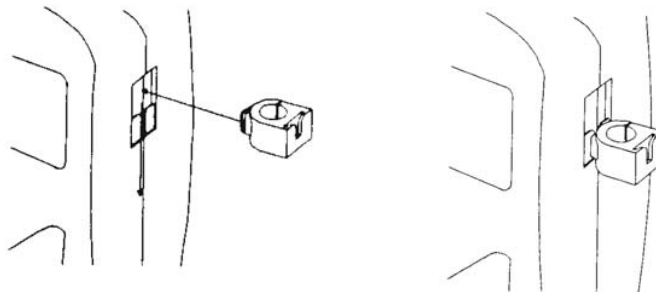

Figure 7: Insert electrode holder

3.2.4 To attach a second electrode holder:

The electrode holder is designed such that you can attach one holder onto another. Up to two electrodes (using the BNC connector and phono-jack) can be used with the meter at any one time.

1. Align the flange of the second electrode holder with the slot of the first holder (Figure 8).
2. Slide the flange of the second holder into the slot of the first holder until the tops of the holders are aligned and secure.

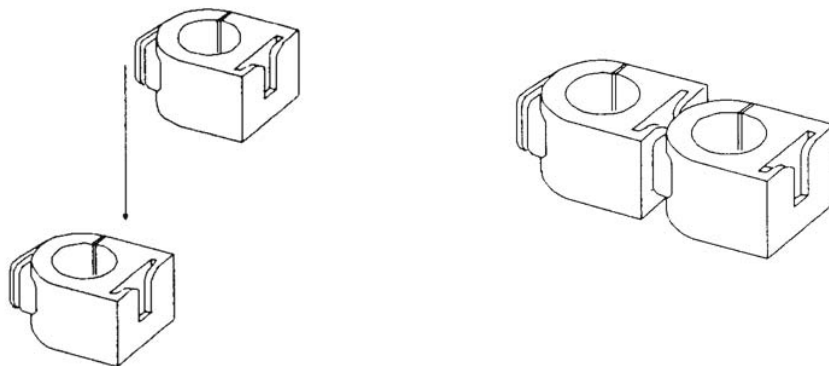

Figure 8: To attach a second electrode holder

3.2.5 Insert the electrode into the holder

1. Do not use excessive force when inserting electrodes into the holders.
2. Insert the pH electrode into the opening of the first holder until the top housing of the electrode touches the top of the holder.
3. If you are using a separate temperature probe, insert the probe into the opening of the second holder until the ridge on the housing touches the top of the holder.

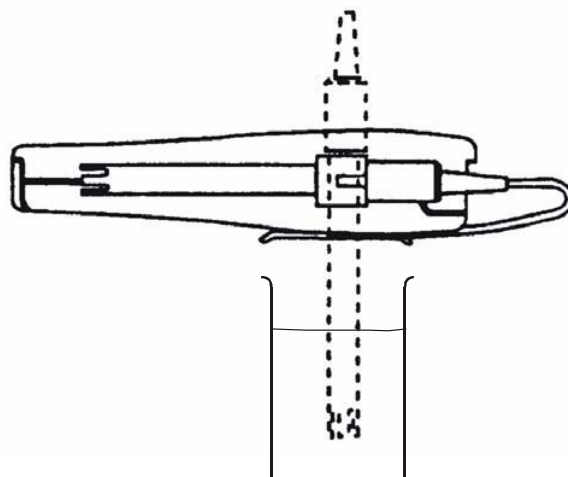

Figure 9: Different positions for one hand operation

NOTE: The holder is designed for probes 12 mm in diameter. Electrodes larger than 12 mm may not fit in the holder. Forcing the electrode into the opening may damage the holder or your electrode.

The electrode holders can be attached in different positions for greater flexibility in measurement and storage purposes. Simply slide out the electrode holders and reorient into appropriate orientation before putting into position.

3.3 Connecting the AC/DC Adapter

Besides using four AAA-sized batteries as a power source, the pH 11/110 meter can also operate from the power mains using an AC/DC power adapter either at 120/220 VAC (sold separately). This is extremely useful if you have an A.C. power source available (e.g. laboratory).

Before plugging in, switch off the meter and the power source of adapter. This is a safety precaution that should be adhered to safeguard your meter.

1. Switch off the meter and power sources.
2. Select the correct AC/DC Adapter either at 120/220 VAC which matches your input mains voltage.
3. Select the correct output voltage of the AC/DC adapter. (Output Voltage: 9 to 15 V DC, Current: ≥ 50 mA).
4. Gently insert the power adapter D.C. jack into the meter power socket.
5. Switch on the power source of the adapter followed by the meter.

3.4 Connecting the RS232C Cable (Only for pH 110)

The pH 110 meter provides a RS232C output for you to transmit your readings either to a printer or a computer via a cable. This is useful in instances where the meter is used for continuous monitoring of a certain process or experiment. Data output to the printer or the computer can then be evaluated.

The data is output in the ASCII format. This format allows the data to be imported by a wide variety of software that read ASCII data (e.g. Microsoft's Excel, Lotus, Quattro-pro etc.). A complimentary Data Acquisition Software (DAS) is provided and it captures data transmitted into an ASCII file for later use.

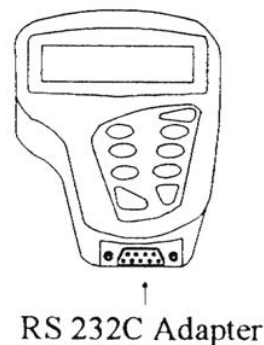

Figure 10: Location of RS232C

1. Open the printer port cover located at the bottom end of the meter. Do not use excessive force when doing this. See Figure 10.
2. Noting the orientation of the RS232C connector, plug the male connector into the RS232C port of the meter.
3. Fasten the RS232C connector by fastening the two screws at the side of the male RS232C connector.

3.4.1 RS232C Configuration

The pH 110 meter has a 9 pin female RS232C connector with the following pin out:

PIN NO.	DESCRIPTION
1	-
2	Transmit Data
3	-
4	-
5	CTS (Clear to Send)
6	-
7	GND (Ground)
8	-
9	-

A one-to-one connection can be made with a 9 pin RS232C port of the computer.

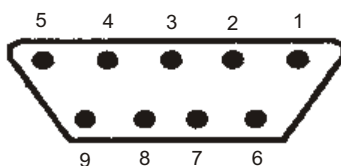

In case pH 110 meter's output has to be sent to a 25 pin RS232C connector, the following cable configuration may be used:

pH 110	25 pin connector
2 (TxD)	(RxD) 3
5 (CTS)	(RTS) 4
7 (GND)	(GND) 7

4 CALIBRATION

4.1 Important Information on Meter Calibration

When you re-calibrate your meter, previous pH and Relative mV calibration points are replaced on a point by point basis. For example, if you previously calibrated your meter at pH 4.01, 7.00, and 10.01, and you have now re-calibrated at pH 7.00, the meter retains the old calibration data at pH 4.01 and pH 10.01. To view current calibration points, see section 9.3 - P2.0: Viewing Previous Calibration Data on page 38.

To completely re-calibrate your meter, or when you use a replacement probe, it is best to set the meter to its factory defaults and re-calibrate the meter at all points. To reset the meter to its factory defaults, see section 9.6.2 - User Reset on page 43.

4.2 Preparing the Meter for Calibration

Before starting calibration, make sure you are in the correct measurement mode. When you switch on the meter, the meter starts up in the units last used. For example, if you shut the meter off in “mV” units, the meter will read “mV” units when you switch the meter on.

Be sure to remove the protective electrode storage bottle or rubber cap of the electrode before calibration or measurement. If the electrode has been stored dry, wet the electrode in tap water for 10 minutes before calibrating or taking readings to saturate the pH electrode surface and minimise drift.

Wash your electrode in deionised water after use, and store in electrode storage solution. If storage solution is not available, use pH 4.01 or 7.00 buffer solution.

Do not reuse buffer solutions after calibration. Contaminants in the solution can affect the calibration, and eventually the accuracy of the measurements. See section 15.3 - Calibration Solutions on page 67 for information on our high-quality pH buffer solutions.

It is recommended that you perform at least a 2-Point Calibration using standard buffers that adequately cover the expected measurement range prior to measurement. 1-Point Calibration can also be used for quick measurements. Make sure that the calibration point is close to the sample value to be measured.

4.2.1 pH 11 meter calibration

The pH 11 meter is capable of up to 5-point pH calibration to ensure accuracy across the entire pH range of the meter. You can select from the following buffer options:

- USA buffers --- pH 1.68, 4.01, 7.00, 10.01, and 12.45.
- NIST buffers --- pH 1.68, 4.01, 6.86, 9.18, and 12.45.

4.2.2 pH 110 meter calibration

The pH 110 meter features four separate internationally recognised buffer standards. Select the buffer standard you require in section 9.2.2 - P1.2: Select Calibration Buffer Options on page 35.

This meter is capable of up to 6-point pH calibration, depending on the buffer standard selection. You can select from the following buffer options:

- USA buffers --- pH 1.68, 4.01, 7.00, 10.01, and 12.45.
- NIST buffers --- pH 1.68, 4.01, 6.86, 9.18, and 12.45.
- DIN buffers --- pH 1.09, 3.06, 4.65, 6.79, 9.23, and 12.75.
- PWB (Low Ionic): pH 4.10 and 6.97

The meter automatically recognises and calibrates to these standard buffer values, which makes pH calibration faster and easier.

4.3 pH Calibration with ATC

NOTE: We recommend that you perform at least 2-point calibration using standard buffers that bracket (one above and one below) the expected sample range.

1. If necessary, press the MODE key to select pH mode. The pH indicator appears in the upper right hand corner of the display.
2. Rinse the probe thoroughly with de-ionised water or a rinse solution. Do not wipe the probe; this causes a build-up of electrostatic charge on the glass surface.
3. Dip the probe into the calibration buffer. The end of the probe must be completely immersed into the sample. Stir the probe gently to create a homogeneous sample.
4. Press CAL/MEAS key to enter pH calibration mode. The CAL indicator will be shown. The primary display will show the measured reading while the smaller secondary display will indicate the pH standard buffer solution.
5. Wait for the measured pH value to stabilise (The READY indicator will be shown only if it is activated in the set up menu).
6. Press HOLD/ENTER key to confirm calibration. The meter is now calibrated to the current buffer.

See figure on right.

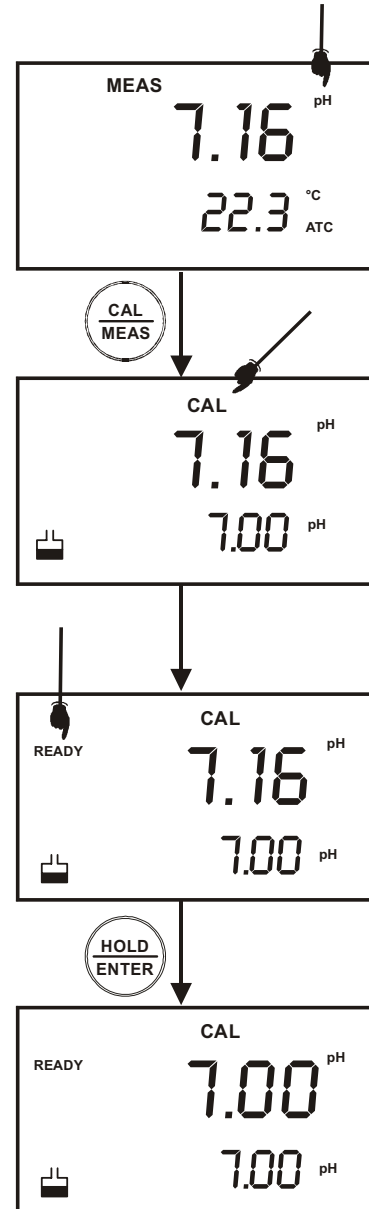

Figure 11: pH Calibration sequence

7. Rinse the probe with de-ionised water or a rinse solution, and place it in the next pH buffer.
8. Follow steps 5 and 6 for additional calibration points. See Figure 12.
9. When all the calibration points set in the Unit Configuration Setup (see P1.3 Select Number of pH Calibration Points on page 36) are completed, the meter returns to Measurement mode automatically. However, if you wish to terminate the calibration without completing the number of points as set in the Unit Configuration Setup menu, press CAL/MEAS to return to pH measurement mode.

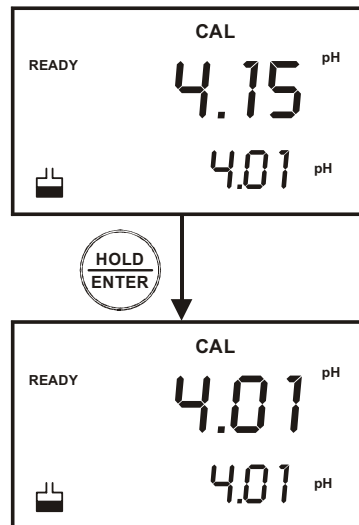

Figure 12: Proceed to next calibration point

NOTES:

1. To exit from pH calibration mode without confirming calibration, DO NOT press ENTER in step 6. Press CAL/MEAS instead.
2. To limit the number of pH buffer values available during calibration, see P1.3 Select Number of pH Calibration Points on page 36.

4.4 mV Calibration (Offset) (Only for pH 110)

With pH 110 meter, you can perform a calibration or an offset of up to ±150 mV. Note: For Oxidation reduction Potential (ORP) or Redox measurements, an ORP electrode must be used.

1. While in the measurement function, press MODE to enter the mV mode. The mV indicator appears in the upper right hand corner. See figure at right.
2. Press the CAL/MEAS key. The CAL indicator appears above the primary display. The primary display shows the relative mV reading and the secondary display shows the absolute mV value.
 - *If you have never calibrated relative mV or if the meter has been reset, the value shown in the primary display is the same as the absolute mV value.*
 - *“R.” annunciator will appear once mV calibration is performed, an indication of mV offset.*
3. Press the MI/▲ or MR/▼ keys to enter the relative mV value that matches your desired reading.
4. Press the HOLD/ENTER key to confirm the reading and to return to the measurement mode. The primary display now shows the relative mV reading.

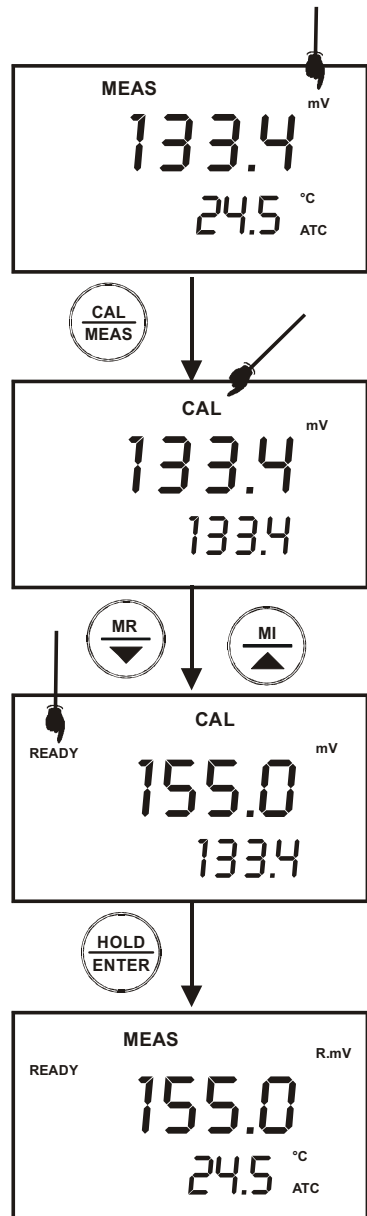

Figure 13: mV calibration sequence

NOTES:

1. To view the mV offset value, see section 9.4.2 - View mV Offset on page 40.
2. To reset all calibration and offset values in memory to the factory default settings, see section 9.6.1 - Calibration Reset page 42.

4.5 Temperature Calibration

The temperature sensor is factory calibrated. Calibrate the temperature probe only if you suspect temperature errors may have occurred over a long period of time or if you have a replacement temperature probe. This procedure offers offset adjustment of probe to ensure more accurate temperature measurement.

1. Make sure the ATC probe (or temperature connector of the electrode) is connected to the phono-socket (see Figure 6).
2. Switch the meter on. The ATC annunciator will appear at the right-hand side of the LCD. Press the MODE key to select pH mode.
3. Press the CAL/MEAS key to enter pH calibration mode. The CAL indicator will appear above the primary display.
4. While in pH calibration mode, press the MODE key to enter temperature calibration mode. The primary display shows the measured temperature reading according to the last set offset¹ and the secondary display shows the factory calibrated temperature measurement.
5. Dip the ATC probe (or electrode) into a solution of known temperature (i.e. a temperature bath). Allow time for the temperature probe to stabilise.
6. Scroll with the MI/▲ or MR/▼ keys to set the correct temperature value (i.e. the temperature of the temperature bath). You can adjust the reading in increments of 0.1°C.
7. Once you have selected the correct temperature, press the HOLD/ENTER key. The meter automatically returns to pH measurement mode. See Figure 14.

NOTES:

You can offset the temperature reading up to ±5°C from original reading.

To exit this program without confirming the temperature calibration value, DO NOT press ENTER. Press CAL/MEAS instead.

¹ It displays the value being measured currently, offset by the last calibration.

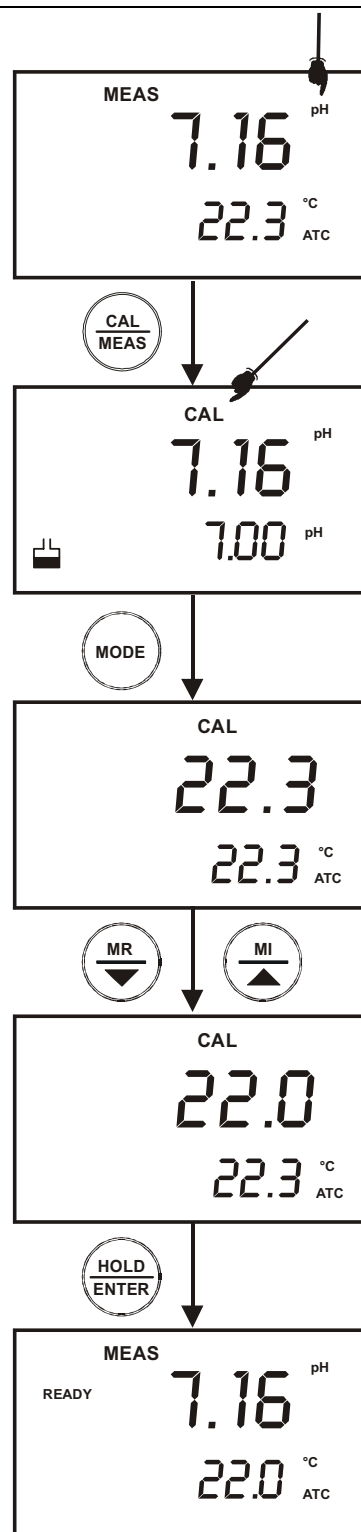

Figure 14: Temperature calibration

5 MEASUREMENT

This meter is capable of taking measurements with automatic or manual temperature compensation. Automatic temperature compensation only occurs when a temperature sensor is plugged into the meter. If there is no temperature sensor plugged into the meter, the default manual temperature setting is automatically 25.0 °C. You can manually set the temperature to match your working conditions using a separate thermometer.

NOTE: Remove the protective rubber cap or soaker bottle of the electrode before proceeding with measurement. Take care not to exert too much force as this may cause damage to the electrode.

5.1 Automatic Temperature Compensation

For automatic temperature compensation (ATC) simply plug the temperature probe into the meter. The ATC indicator will light up on the LCD.

NOTE: If you are using a temperature probe, the probe must be submersed in the liquid you are measuring.

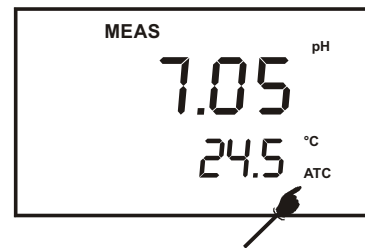

Figure 15: ATC indicator

5.2 Manual Temperature Compensation

IMPORTANT: For manual compensation, you must disconnect the temperature probe. The [ATC] annunciator will disappear from the LCD.

1. Switch the meter on. Press the MODE key to select pH mode.
2. Press the CAL/MEAS key to enter pH calibration mode. The CAL indicator will appear above the primary display.
3. While in pH calibration mode, press the MODE key to enter temperature calibration mode. The primary display act as the adjustable temperature setting and the secondary display shows the default temperature value of 25°C or indicates the last set temperature setting.
4. Check the temperature of your sample using an accurate thermometer.
5. Press the MI/▲ or MR/▼ keys to set the temperature to the measured value from step 4.
6. Press HOLD/ENTER key to confirm the selected temperature and to return to the pH measurement mode.
7. The meter will now compensate pH readings for the manually set temperature.

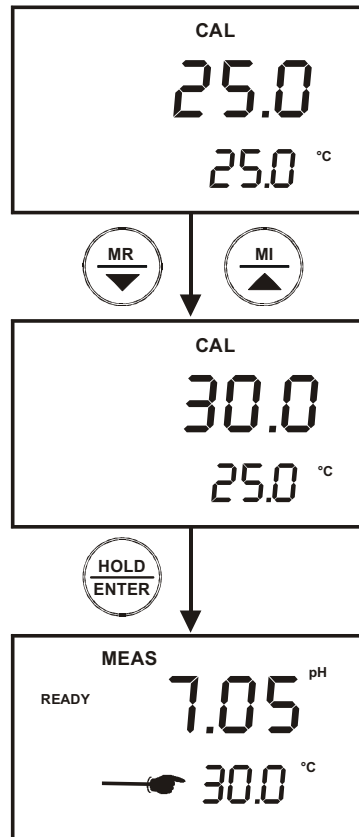

Figure 16: Manual temperature compensation

See Figure on right.

NOTES:

To exit this program without confirming the manual temperature compensation value, DO NOT press ENTER in step 6. Press CAL/MEAS instead.

5.3 Taking Measurements

Be sure to remove the electrode soaker bottle or protective rubber cap on the electrode before measurement.

To take readings:

1. Rinse the probe with de-ionised or distilled water before use to remove any impurities adhering to the probe body. If the pH electrode has dehydrated, soak it for 30 minutes in electrode storage solution or 2M – 4M KCl solution (sold separately).
2. Press ON to switch on meter. The MEAS annunciator appears on the top center of the LCD. The ATC indicator appears in the lower right-hand corner to indicate Automatic Temperature Compensation (section 5.2 on Manual Temperature Compensation).
3. Dip the probe into the sample.

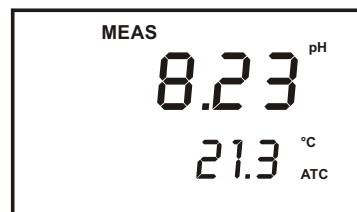

Figure 17: Measurement mode

When dipping the probe into the sample, the sensor or the glass bulb of the electrode must be completely immersed into the sample. Stir the probe gently in the sample to create a homogeneous sample.

4. Allow time for the reading to stabilise. Note the reading on the display.
5. To toggle between pH and mV (or Rel mV) readings, press the MODE key.

5.3.1 **Taking measurements with READY indicator selected on**

If the READY indicator has been activated, the READY annunciator lights when the reading is stable² *. You can switch the READY indicator on or off in SETUP program. See 9.2.1 - P1.1: READY Indicator and Auto Hold function on page 34.

5.3.2 **Taking measurements with the AUTO HOLD feature selected on**

This feature is available on model pH 110 only.

When a reading is stable for more than 5 seconds, the AUTO HOLD feature will automatically “HOLD” the reading. The “HOLD” indicator appears on the left side of the display. Press the HOLD/ENTER key to release the reading. Switch the Auto Hold feature on or off in SETUP program in section 9.2.1 - P1.1: READY Indicator and Auto Hold function on page 34.

² The READY indicator appears and the reading holds until the measured value exceeds the tolerance (± 0.02 pH; ± 0.2 mV <400; ± 2 mV > 400). Then, the READY annunciator turns off.

6 HOLD FUNCTION

This feature lets you freeze the value of the pH, mV (or relative mV) and temperature readings for a delayed observation. HOLD can be used any time when in MEAS mode.

1. To hold a measurement, press the HOLD/ENTER key while in measurement mode. "HOLD" will appear on the display. See Figure 18.
2. To release the held value, press HOLD/ENTER key again. Continue to take measurements.

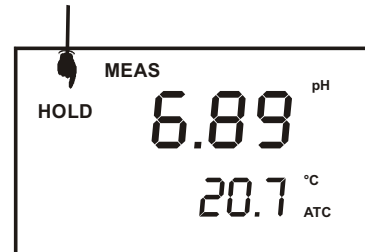

Figure 18: Press HOLD to freeze reading

NOTE:

- a. This meter shuts off automatically 20 minutes after last key is pressed. If the meter is shut off either automatically or manually, the HOLD value will be lost. For longer storage, use the Memory functions described in page 21.
- b. For pH 110 model only: The pH 110 meter has an Auto Hold feature. When this feature is switched on, the display will automatically "HOLD" a reading that has been stable for more than 5 seconds. When "HOLD" indicator appears, press the HOLD/ENTER key to release the reading. To switch on or off the Auto Hold feature, see section 9.2.1 - P1.1: READY Indicator and Auto Hold function on page 34.

7 MEMORY FUNCTION

The memory function is available in both pH 11 and pH 110 meters. These meters store data in sets:

- pH and temperature
- mV and temperature
- Relative mV and temperature (for pH 110)

The pH 11 meter can store up to 50 sets of data while pH 110 meter can store up to 100 sets of data. You can store data in any combination of values. For example, you can store 17 pH and 19 mV values.

7.1 Memory Input

1. During any measurement function (MEAS), press MI/▲ key to input any data into the memory.
2. MEM, “Sto” and memory number will flash. The meter then returns to measurement mode.
3. If the memory is full, the display will flash “MEM – FUL” momentarily (Figure 20). The first value stored will be erased to create space for the new value.

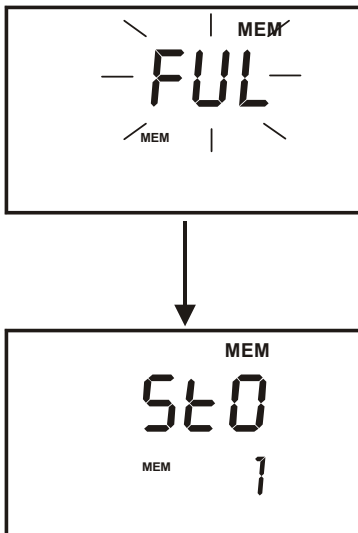

Figure 20: Memory full

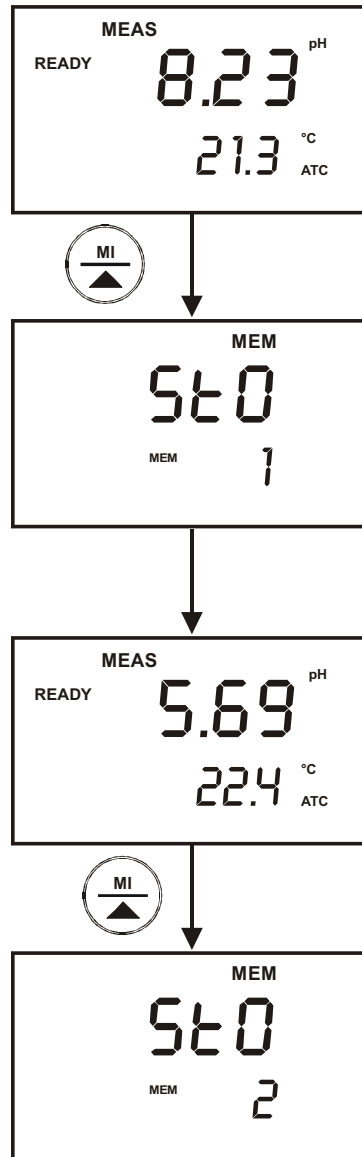

Figure 19: Data storage in memory

7.2 Memory Recall

This function recalls the previous readings stored in the memory. You can only access MR from the measurement mode. Memory recall is in “Last In First Out” order. To recall readings:

1. Press the MR/▼ key once to retrieve the last reading stored. The memory location screen – MEM, “Loc” and the memory number – will flash on the display.
2. Press the HOLD/ENTER key to recall the reading stored under that memory number.
3. To display next stored reading, press HOLD/ENTER key. The display automatically moves to the next lower memory location screen.
4. To view a stored reading in a specific memory location, press MI/▲ or MR/▼ keys to locate it, and press HOLD/ENTER key to display the reading.

NOTE: Readings stored in memory are retained even if the unit is turned off. To erase all readings stored in memory, use the SETUP in section 9.7 – P 6.0: Memory Clear (CLr) on page 44.

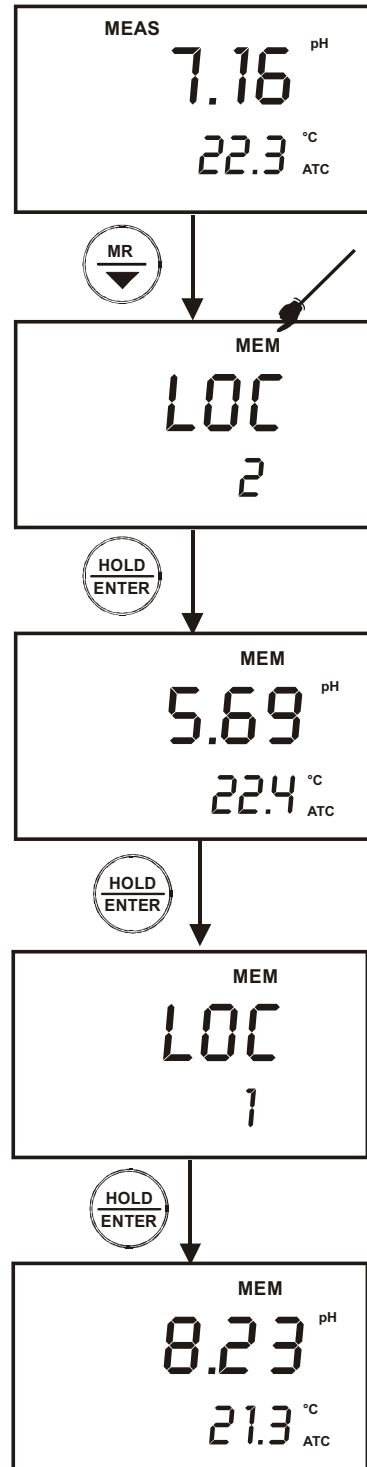

Figure 21: Memory recall

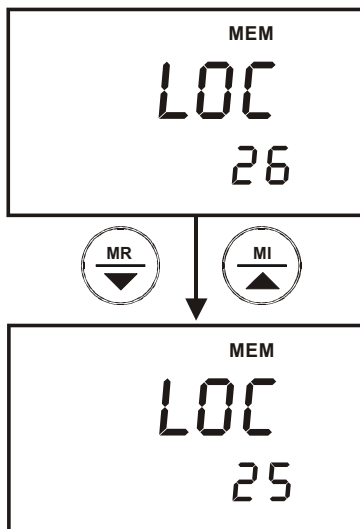



Figure 22: Scroll up or down for specific memory location

8 PRINT FUNCTION (Only for pH 110)

The pH 110 meter is equipped with an RS232 communication port and a PRINT () key that facilitate the printing of data from the meter to a printer or computer.

8.1 Using pH 110 Meter With Printer or Computer

1. To use the pH 110 directly with a printer, the printer should have either a 9 pin or a 25 pin RS 232C serial port.
2. Communication settings of the printer or computer's data acquisition software (CyberComm Portable DAS) MUST match the following parameters:
 - a. Baud Rate: 9600
 - b. Parity Bit: None
 - c. Stop Bit: One
 - d. Data Bit: 8
 - e. Flow Control: None
3. Please refer to your printer's or computer's instruction manual for more information on its communication setup protocol.
4. Use 9-pin cable (Refer to section 15 - LIST OF ACCESSORIES on page 65) to connect the meter to the printer. If the printer has a 25 pin connector, use the 9 to 25 pin cable or make your own cable taking note of the connection parameters as described in section 3.4 - Connecting the RS232C Cable (Only for pH 110) on page 9.
5. Turn on pH 110 meter and note the following:
 - f. For printer, ensure it is powered on and paper is loaded.
 - g. For computer, ensure that Eutech Instruments' CyberComm Portable Data Acquisition Software is installed and activated. See section 10.3 -

Running CyberComm Portable on page 52.

6. To send data to the printer or computer, press the PRINT key.

8.2 Sending Data To Computer or Printer

When the PRINT key is pressed, there are two options:

- dAt / CUr: Print Data on Timed Interval basis. You can print any data automatically based a pre-set timing from 5 to 30 seconds.
- dAt / StO: Print Stored Data from Memory. This simply dumps all data stored in memory. You cannot print data from selected memory locations.

See Figure below.

From pH or mV measurement mode.

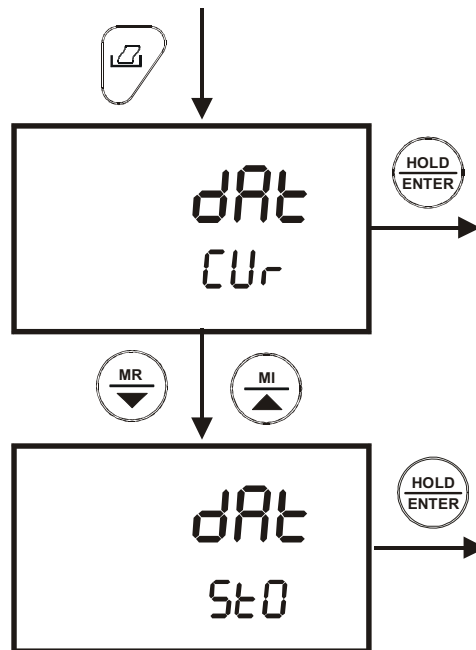

Figure 23: Print data based on timed interval or from memory

8.2.1 Print Current Data Manually

To manually print any data that is currently being measured:

1. From measurement mode, press HOLD key to freeze reading. See Figure 24.
2. Print PRINT (⏏) key.
3. The “Prn – CUr” annunciator will appear and flash for about 0.5 seconds. The data is transmitted to the printer or computer.
4. The meter returns to measurement mode.
5. Repeat steps 1 to 3 for next measurement.

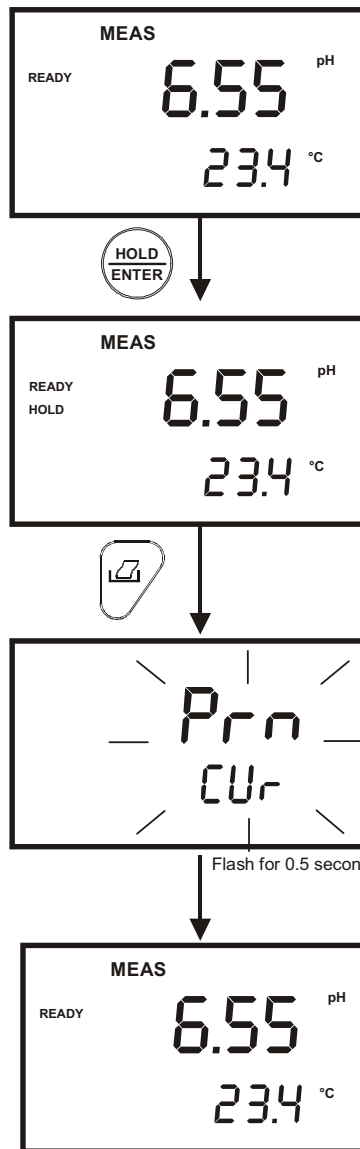

Figure 24: Print current data manually

8.2.2 Print Data on Timed Interval

This feature is useful to automate printing and downloading ‘live’ measurement values into computer. The time interval setting can range from 5 to 30 seconds.

1. From pH or mV measurement mode, press PRINT key.
2. Select “Dat/Cur” screen and press HOLD/ENTER key.
3. The “Sec 5” screen appears. The default value is 5 seconds time interval. See Figure 25.
4. Press MI/▲ or MR/▼ key to set a value suitable for your application.
5. Press HOLD/ENTER key.
6. The meter goes into measurement mode with MEM annunciator flashing.
7. At a pre-set time interval, the screen flashes “Prn/CUr” momentarily (printing data) and switches back to measurement mode with MEM annunciator flashing.
8. To stop printing, press PRINT key. The MEM annunciator disappears and the meter is on measurement mode.

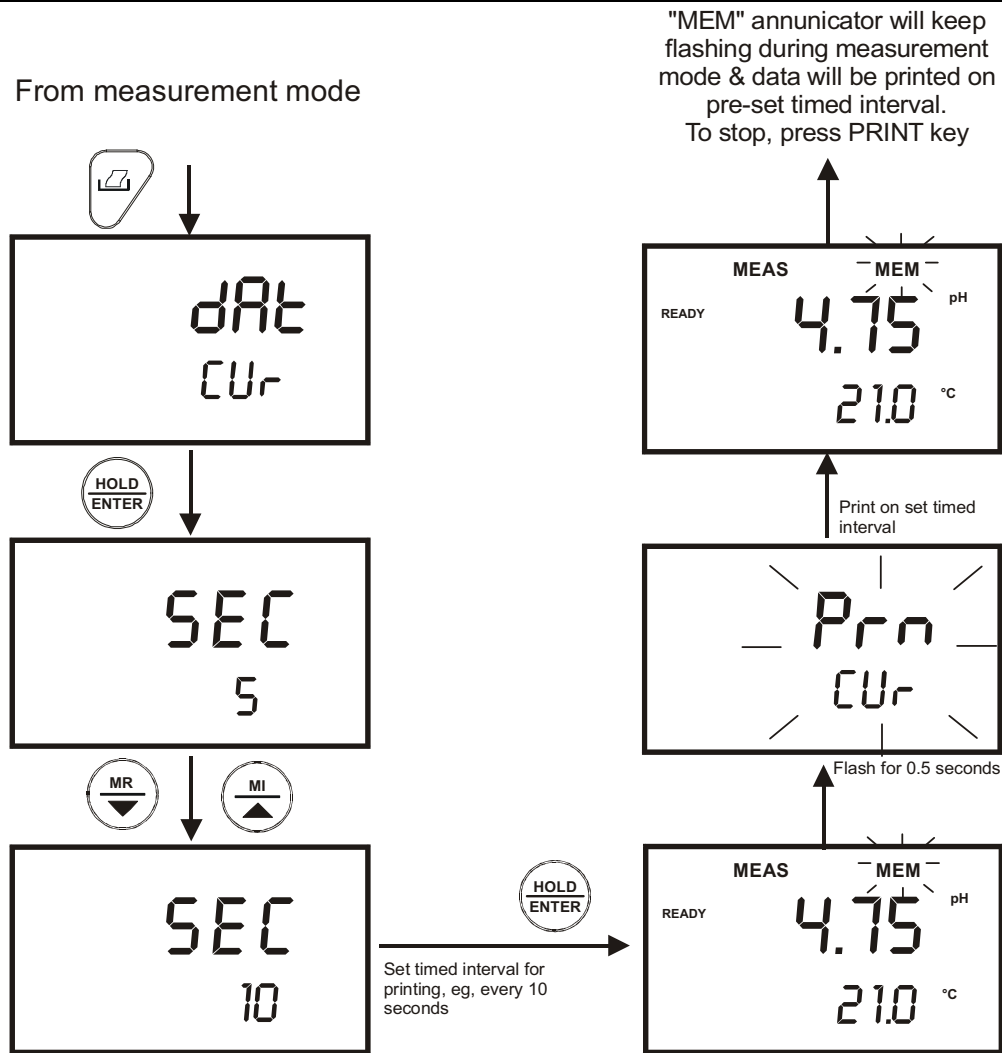

Figure 25: Print data on timed interval

8.2.3 Print Data from Stored Memory

The pH 110 meter can print data that is stored in the memory. You can print out all stored data or selected data based on its memory location.

To Print All Stored Data

1. From measurement mode, press PRINT key.
2. Use MI/▲ or MR/▼ key, select “dAt – StO” option and press HOLD/ENTER key. See Figure 23.
3. At the “SEC – 0” option, use MI/▲ or MR/▼ key to select number of seconds to print each set of stored data. This setting gives flexibility to match the meter to a printer’s or computer’s ability (or buffer size) to accept data and prevent overflow.

4. Press HOLD/ENTER key. The “Prn” primary display will flash until all data is printed.
5. To stop printing, press PRINT key and exit to measurement mode. See Figure 26.

NOTE: All stored memory will remain in the meter after printing.

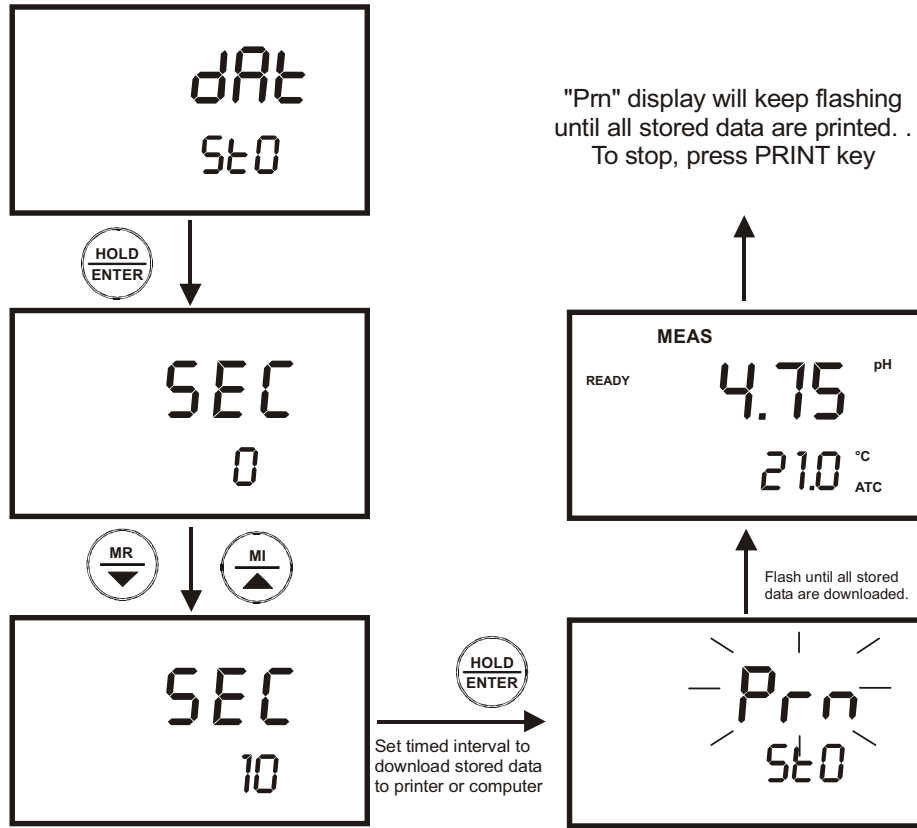

Figure 26: Print all stored data

To Print Selected Stored Data:

1. From measurement mode, press MR/▼ key.
2. “MEM” indicator appears and the last memory input location is displayed.
3. Press MI/▲ or MR/▼ key to select a specific memory location, and press HOLD/ENTER key.
4. When ready, press PRINT key.
5. The screen flashes “Prn/CUr” for about 0.5 seconds and switches back to the stored data of the specific memory location.
6. Press HOLD/ENTER key. The meter is now ready to recall the next stored data in the following memory location. See Figure 27.

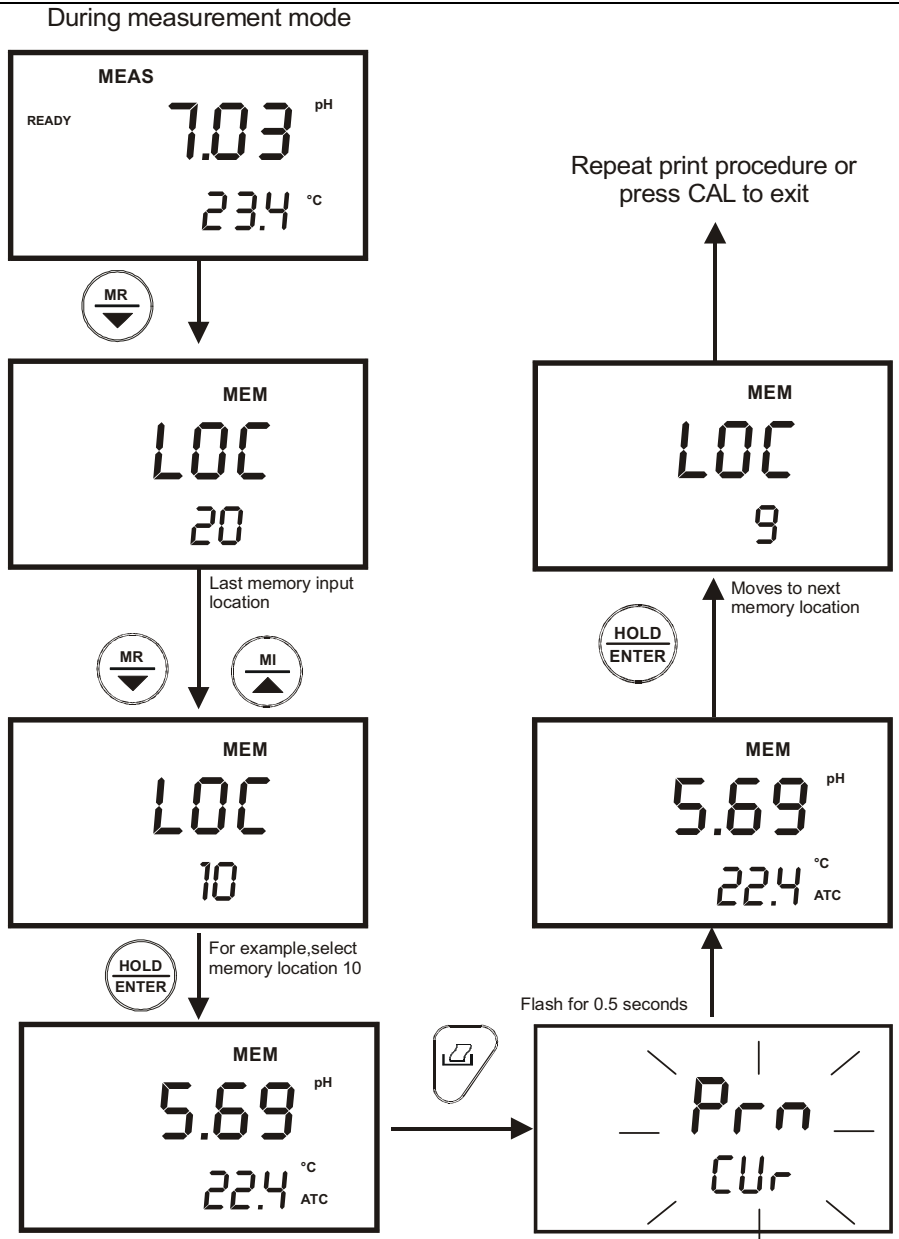

Figure 27: Print based on selected stored data from memory

For more information about Eutech Instruments' CyberComm Portable Data Acquisition Software programme, see section 10 - CYBERCOMM PORTABLE DAS (Only for pH 110) on page 45.

9 ADVANCED SETUP FUNCTIONS

The advanced setup mode lets you customised your meter's preferences and defaults. The pH 11 and pH 110 meters feature different sub groups that organise all setup parameters.

The sub-groups are:

For pH		For mV	
P1.0	Unit Configuration	P1.0	Unit Configuration
P2.0	Calibration Points	P2.0	Not available
P3.0	Electrode Status	P3.0	Electrode Status (pH 110)
P4.0	Auto Power Mode	P4.0	Auto Power Mode
P5.0	Reset	P5.0	Reset
P6.0	Memory Clear	P6.0	Memory Clear

See Figure 28.

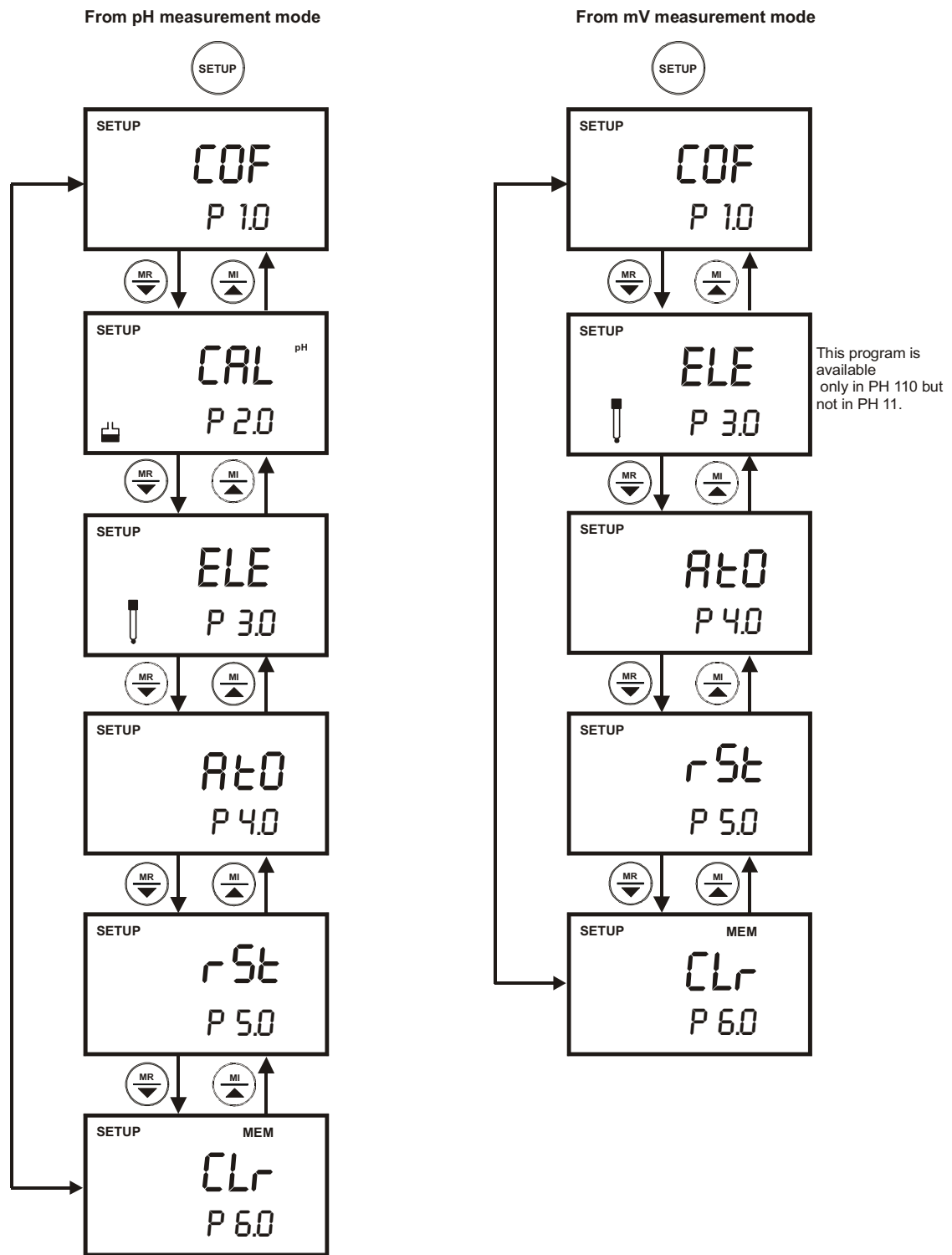

Figure 28: Setup overview for pH and mV operations

9.1 Advanced SETUP Mode Overview

Press the SETUP key to enter Setup mode. Press the MI/▲ and MR/▼ keys to scroll through the sub groups.

9.1.1 pH Setup mode

<p>SETUP COF P 1.0</p>	<p><u>P1.0: Unit Configuration</u> P1.1 Ready indicator (On, Off or Auto Hold) P1.2 Select buffer option P1.3 Number of calibration points: 2, 3, 4 or 5 (or 6 for DIN buffer option) P1.4 Select °C or °F temperature units*** (pH 110 only)</p>
<p>SETUP CAL^{pH} P 2.0</p>	<p><u>P2.0: View Previous pH Calibration Data (View only)</u> P2.1 First calibration point P2.2 Second calibration point P2.3 Third calibration point P2.4 Fourth calibration point P2.5 Fifth calibration point P2.6 Sixth calibration point (for DIN buffer option)</p>
<p>SETUP ELE P 3.0</p>	<p><u>P3.0: View Electrode Data (View only)</u> P3.1 pH electrode offset P3.2 pH electrode slope</p>
<p>SETUP Ato P 4.0</p>	<p><u>P4.0: Select Auto Power On/Off</u> P4.0 Select auto power on or off</p>
<p>SETUP rSt P 5.0</p>	<p><u>P5.0: Reset to Factory Default</u> P5.1 Reset pH calibrated data P5.2 User reset back to factory default values</p>
<p>SETUP MEM CLr P 6.0</p>	<p><u>P6.0: Memory Clear</u> P6.0 Clear all stored readings</p>

9.1.2 mV Setup mode

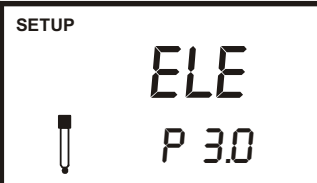
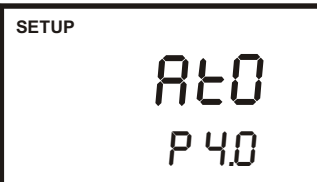
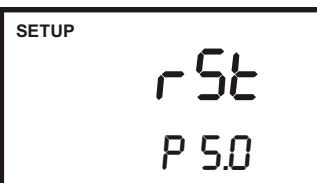
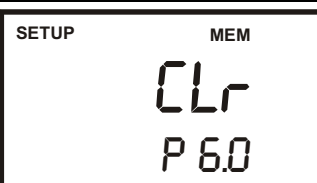
 <p>SETUP COF P 1.0</p>	<p><u>P1.0: Unit Configuration</u> P1.1 Ready indicator (On, Off or Auto Hold) P1.4 Select °C or °F temperature units (pH 110 only)</p>
 <p>SETUP ELE P 3.0</p>	<p><u>P3.0: View Electrode Data (pH 110 only)</u> P3.1 Electrode offset in mV (pH 110 only)</p>
 <p>SETUP Ato P 4.0</p>	<p><u>P4.0: Select Auto Power On/Off</u> P4.0 Select auto power on or off</p>
 <p>SETUP rSt P 5.0</p>	<p><u>P5.0: Reset to Factory Default</u> P5.1 Reset Relative mV calibrated data P5.2 User reset back to factory default values</p>
 <p>SETUP MEM CLR P 6.0</p>	<p><u>P6.0: Memory Clear</u> P6.0 Clear all stored readings</p>

9.2 P1.0 : Unit Configuration

This subgroup program allows customising the meter to your specific needs. You can program the meter to:

1. Select READY function ON or OFF (pH 110 allows you an additional feature of switching the AUTO HOLD function ON or OFF)
2. Select between 2 buffer options (4 buffer options for pH 110)
3. Select the number of pH calibration points
4. Select between °C and °F units for temperature readings (for pH 110 meter only)

Figure 29 on the right shows the setup sequence for this program subgroup.

The following 3 pages explain each of the program in detail.

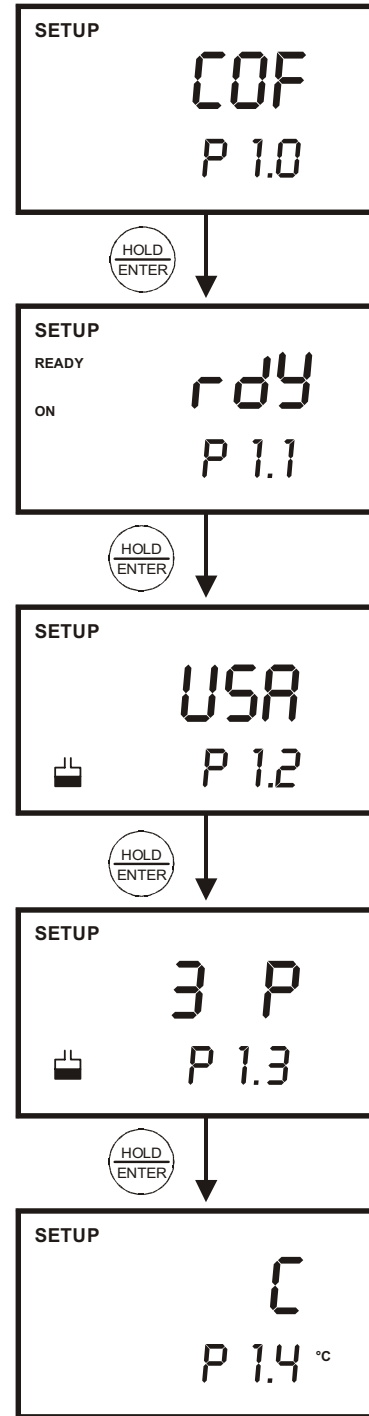

Figure 29: Setup sequence for unit configuration

9.2.1 P1.1: READY Indicator and Auto Hold function

Program P1.1 lets you select “READY indicator on” to indicate when the reading is stable, or select “READY indicator off” for faster meter response.

In the pH 110 meter, program P1.1 also lets you switch the auto hold function on or off. Select auto hold on to “HOLD” the reading when it is stable for more than 5 seconds. The display automatically freezes, and the HOLD indicator appears on the left side of the display. Press the HOLD/ENTER key to release the display and access other functions. Select auto endpoint off to deactivate this feature.

From measurement mode

1. Press SETUP key to enter Set Up mode.
2. At COF – P1.0 parameter, press HOLD/ENTER key to select parameter P1.1.
3. Press the MI/▲ or MR/▼ keys to select the configuration you require.
 - OFF switches the READY indicator off.
 - ON switches the READY³ indicator on.
 - ON and HOLD together switches the auto hold feature on (for pH 110 meter only).
4. Press the HOLD/ENTER key to confirm selection and to proceed to step 2 of P1.2. Press the CAL/MEAS key to return to measurement mode.

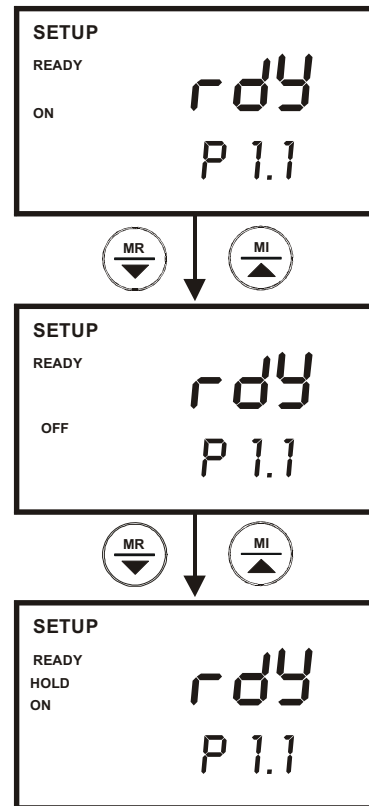

Figure 30: P1.1 - Configure READY ON, OFF or HOLD

NOTE:

Meter default is set for READY indicator on and auto hold function off.

³ The READY indicator appears and the reading holds until the measured value exceeds the tolerance (± 0.02 pH; ± 0.2 mV <400; ± 2 mV > 400). Then, the READY annunciator turns off.

9.2.2 P1.2: Select Calibration Buffer Options

The types of pH calibration buffer options available are:

Meter	Meter Display	pH Calibration Buffer Options
pH 11	USA nSt	USA buffers --- pH 1.68, 4.01, 7.00, 10.01, and 12.45. NIST buffers --- pH 1.68, 4.01, 6.86, 9.18, and 12.45.
pH 110	USA nSt dn PUr	USA buffers --- pH 1.68, 4.01, 7.00, 10.01, and 12.45. NIST buffers --- pH 1.68, 4.01, 6.86, 9.18, and 12.45. DIN buffers --- pH 1.09, 3.06, 4.65, 6.79, 9.23, and 12.75. PWB (Low Ionic): pH 4.10 and 6.97

From measurement mode

Press SETUP key to enter Set Up mode.

1. Press the MI/▲ or MR/▼ keys to scroll through subgroups until you view parameter P1.0.
2. Press the HOLD/ENTER key two times to select parameter 1.2.
3. Press the MI/▲ or MR/▼ keys to select the buffer set you require:
4. Press the HOLD/ENTER key to confirm selection and to return to the subgroup menu. Press CAL/MEAS key to return to measurement mode.

See Figure 31.

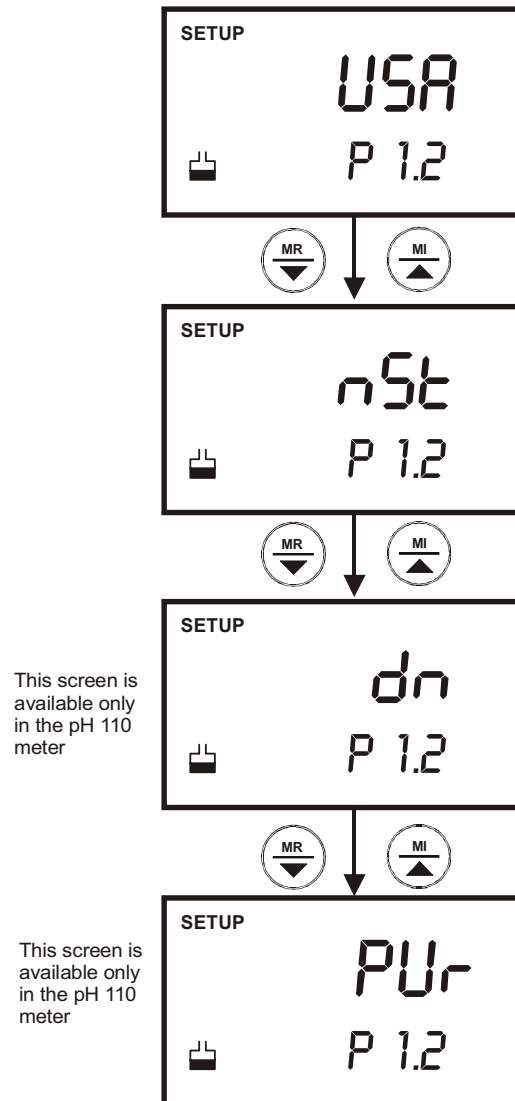

Figure 31: P1.2 - Select pH calibration buffer standards

9.2.3 P1.3 Select Number of pH Calibration Points

Program P1.3 lets you select the number of calibration points that appear in pH calibration mode: 2, 3, 4, or 5 (or 6 with DIN buffer option). This lets the meter scroll through the calibration points more quickly if you regularly calibrate at less than 5 points.

From measurement mode:

1. Press SETUP key to enter Set Up mode.
2. Press the MI/▲ or MR/▼ keys to scroll through subgroups until you view parameter P1.0.
3. Press the HOLD/ENTER key three times to select parameter 1.3.
4. Press the MI/▲ or MR/▼ keys to select 2, 3, 4, or 5 point pH calibration (up to 6 points for DIN calibration set with pH 110 meter).
5. Press the HOLD/ENTER key to confirm selection and to return to the subgroup menu. Press CAL/MEAS key to return to measurement mode.

See Figure 32.

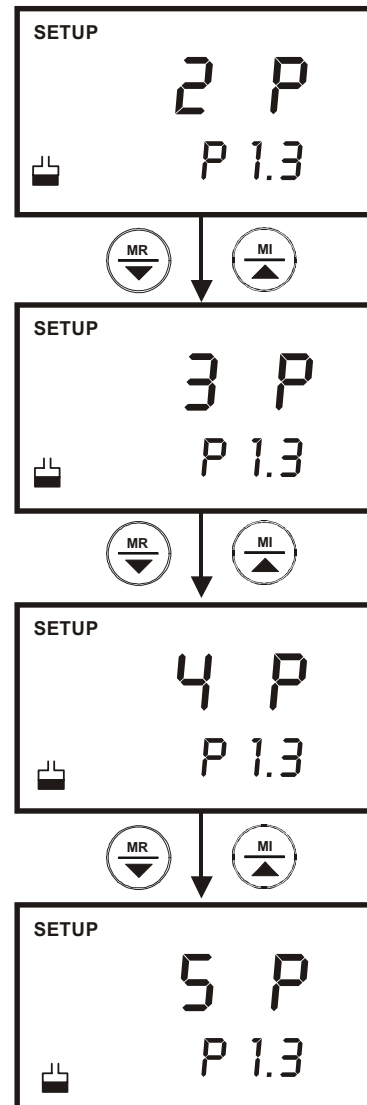

Figure 32: P1.3 - Select number of calibration points

9.2.4 P1.4 Select °C or °F Temperature Units

Available in pH 110 meter only

The pH 110 meter lets you select between °C and °F units for temperature readings.

From measurement mode

1. Press SETUP key to enter Set Up mode.
2. Press the MI/▲ or MR/▼ keys to scroll through subgroups until you view parameter P1.0.
3. Press the HOLD/ENTER key four times to select parameter 1.4.
4. Press the MI/▲ or MR/▼ keys to toggle between °C and °F.
5. Press the HOLD/ENTER key to confirm selection and to return to the subgroup menu. Press the CAL/MEAS key to return to measurement mode.

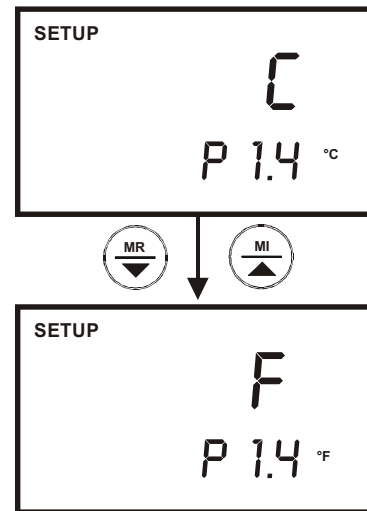

Figure 33: P1.4 - Select temperature units, °C or °F

See Figure 33.

9.3 **P2.0: Viewing Previous Calibration Data**

This mode lets you recall previous calibration data, which helps you know when to re-calibrate your meter. This is a “view only” mode.

From measurement mode:

1. Press the SETUP key to enter Set up mode.
2. Press the MI/▲ or MR/▼ keys to scroll through subgroups until you view parameter P2.0.
3. Press the HOLD/ENTER key repeatedly to view previous calibration data. See Figure 34.
4. When you have scrolled through all calibration data, you will automatically return to the subgroup menu. Press CAL/MEAS key to return to measurement mode.

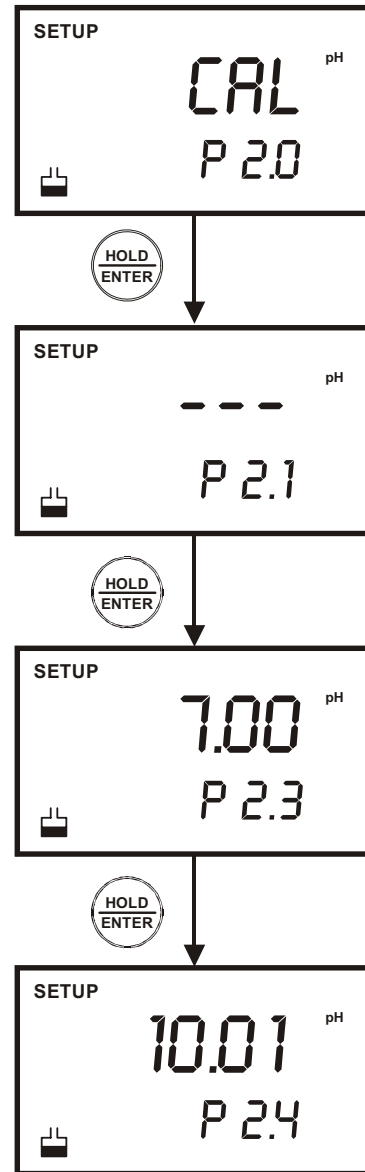

Figure 34: P2.0 - View previous calibration data

NOTES:

If there is no previous calibration data at a particular point, the primary display will show “----”.

9.4 **P3.0: View Electrode Data**

Program 3 has two “view only” options that let you check the electrode parameters for diagnostic purposes.

- From pH measurement mode, you can view the electrode’s offset and slope values.
- From mV measurement mode, you can view the electrode’s relative mV offset value. (pH 110 only)

9.4.1 **View pH Electrode Offset and Slope**

From pH measurement mode:

1. Press the SETUP key to enter Set Up mode.
2. Press the MI/▲ or MR/▼ keys to scroll through subgroups until you view parameter P3.0.
3. Press the HOLD/ENTER key.
4. The display shows the electrode offset value. It is the mV offset at pH 7.00. If you have not calibrated at any buffer, the primary display shows ‘---’.
5. Press the HOLD/ENTER key to proceed to electrode slope display.
6. The display shows electrode slope in percentage. Slope displayed will be the current slope of the slope zone to which a measurement is made or calibration is done.
7. At any point, you can press the CAL/MEAS key to return to measurement mode.

See Figure 35.

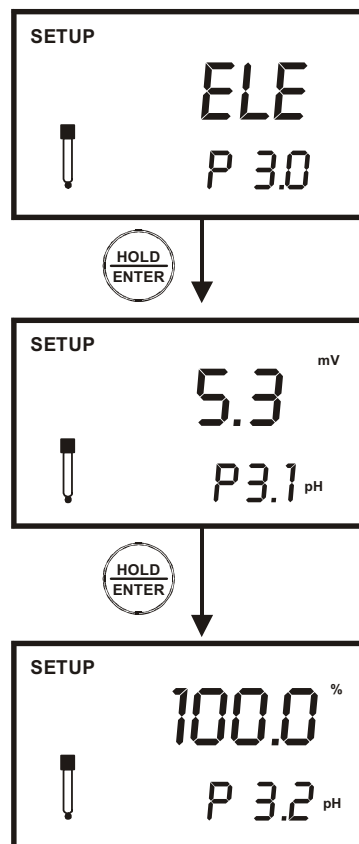

Figure 35: P3.1/3.2 - View pH electrode offset and slope

9.4.2 View mV Offset (Only for pH 110)

If you are in mV measurement mode, the display shows the relative mV offset. You can adjust the relative mV offset in relative mV calibration mode. See section 4.4 - mV Calibration (Offset) on page 15.

From mV measurement mode:

1. If necessary, press the MODE key to select mV measurement mode.
2. From mV measurement mode, press the SETUP key to enter Set Up mode.
3. Press the MI/▲ or MR/▼ keys to scroll through subgroups until you view parameter P3.0.
4. Press the HOLD/ENTER key.
5. The display shows the electrode offset value. It is the relative mV offset. If you have not calibrated at any mV standards, the primary display shows 0.00 mV.
6. Press the HOLD/ENTER key to return to P3.0.
7. At any point, you can press the CAL/MEAS key to return to measurement mode.

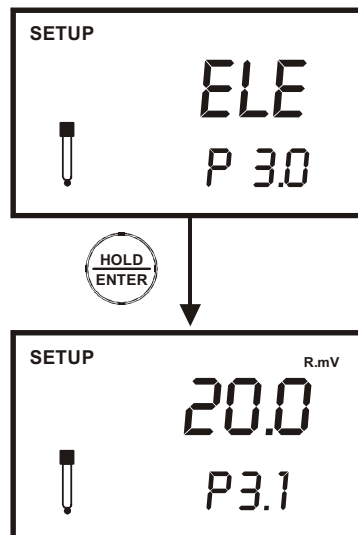

Figure 36: P3.0 - View mV offset value

See Figure 36.

9.5 P4.0 : Auto-Off

In Program P4.0 you can activate the AUTO-OFF option to automatically power off the instrument 20 minutes after the last key selection. This feature is useful for conserving battery power. Under default conditions, the instrument has this option activated.

1. Press the SETUP key to enter Set Up mode.
2. Press the MI/▲ or MR/▼ keys to scroll through subgroups until you view parameter P4.0.
3. Press the HOLD/ENTER key.
4. Press MI/▲ or MR/▼ keys to select options
 - 'YES' - Meter will automatically switch off 20 minutes after the last key operation.
 - 'NO' - Auto Off mode is switched off.
5. Press the HOLD/ENTER key to confirm and return to P4.0.
6. At any point, you can press the CAL/MEAS key to return to measurement mode.

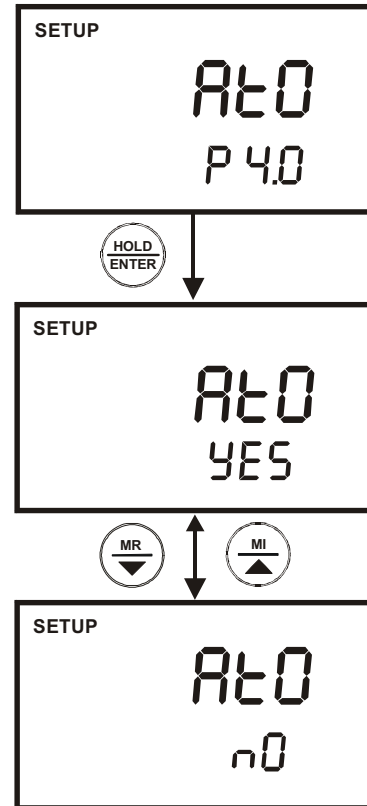

Figure 37: P4.0 - Auto shut off feature

9.6 **P5.0 : Reset to Factory Default**

This mode lets you reset all parameters to factory default settings. There are two levels of reset:

- Calibration Reset: Reset only the calibration values. This clears all previous calibrated values and reset to factory default. See page 68 and 69 for factory default settings.
- User Reset: Clears all data including calibration, memory and other customised setup functions and reset it to factory default. See page 68 and 69 for factory default settings.

9.6.1 Calibration Reset

From measurement mode:

1. Press SETUP key to enter Set Up mode.
2. Press the MI/▲ or MR/▼ keys to scroll through subgroups until you view parameter P5.0.
3. Press the HOLD/ENTER key.
4. Press the MI/▲ or MR/▼ keys to toggle between NO and YES.
 - 'NO' retains current settings
 - 'YES' erase calibration settings.
5. Press the HOLD/ENTER key to confirm selection.
 - If 'NO' is selected, it will retains current settings and proceed to next program P5.2 – User Reset.
 - If 'YES' is selected, all LCD segments will lit up for one second, erase calibration values, and the meter switches to the measurement mode.
6. Otherwise press CAL/MEAS key to return to measurement mode without resetting to factory default.

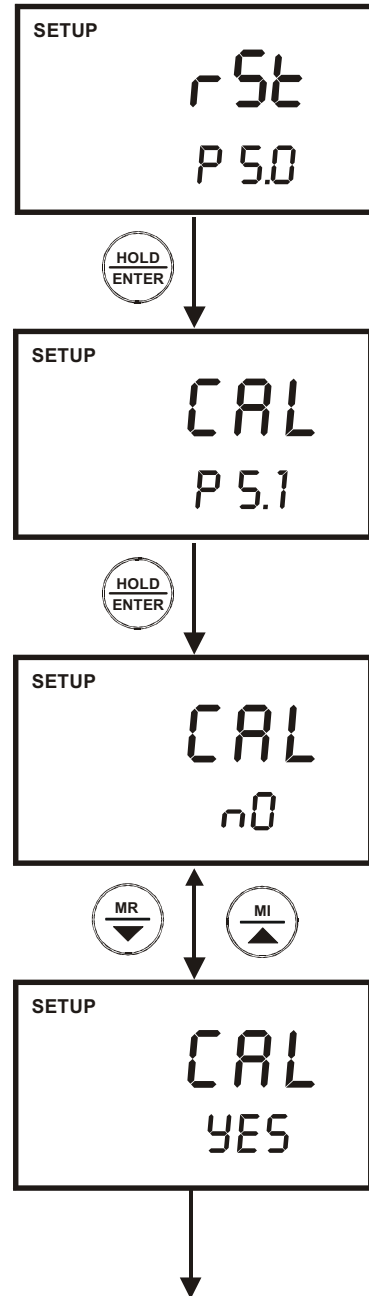

Select either "YES" or "n0", press ENTER key to confirm.

Figure 38: P5.1 - Calibration reset

See Figure 38.

NOTE:

Calibration reset is independent for each measurement parameter.
That is:

- From pH mode, calibration reset will only erase pH calibration values; and
- From mV mode, calibration reset will only erase mV calibration values.

9.6.2 User Reset

This program clears all data including calibration, memory and other customised setup functions and reset it to factory default.

You can skip program P5.1 (Calibration Reset) and proceed straight to Program P5.2:

1. From Program P5.0 - rSt, press HOLD/ENTER key three times to P5.2.
2. Press the MI/▲ or MR/▼ keys to scroll through subgroups until you view parameter P5.0.
 - 'NO' retains current settings
 - 'YES' resets to factory default settings.
3. Press the ENTER key to confirm selection.
 - If 'NO' is selected, it will retain current settings and goes back to program 5.0.
 - If 'YES' is selected, all LCD segments will lit up for one second, resets to factory default settings, and the meter will be in the measurement mode.
4. Otherwise press CAL/MEAS key to return to measurement mode without resetting to factory default.

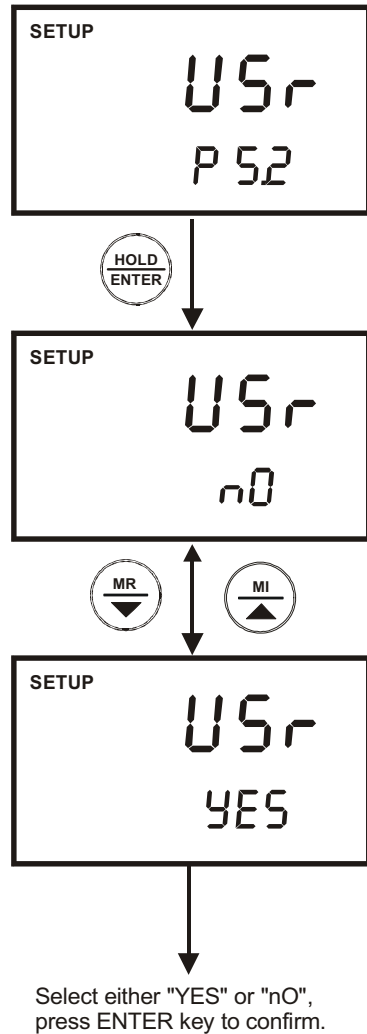

Figure 39: P5.2 - User reset

9.7 **P 6.0: Memory Clear (CLr)**

Use this parameter to clear all memory values when you need to store a new series of values. This lets you avoid confusing the old values with the new ones.

NO is the default setting.

| *NOTE: Selecting YES will wipe out all memory.* |

From measurement mode:

1. Press the SETUP key to enter Set Up mode.
2. Press the MI/▲ or MR/▼ keys to scroll through subgroups until you view the parameter P6.0.
3. Press the HOLD/ENTER key.
4. Press the MI/▲ or MR/▼ keys to toggle between NO and YES.
 - NO retains current memory
 - YES clears all memory.

See Figure 40.

5. Press the HOLD/ENTER key to confirm selection and return to the subgroup menu.
6. Press CAL/MEAS key to return to measurement mode.
7. Otherwise press CAL/MEAS key to return to measurement mode without resetting to factory default.

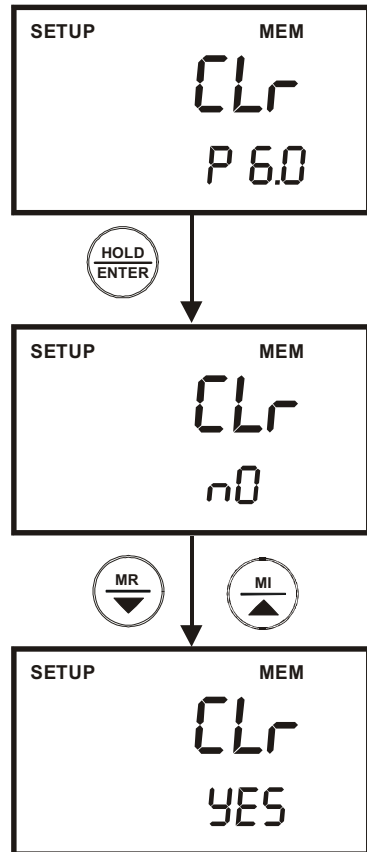

Figure 40: P6.0 - Clear memory

10 CYBERCOMM PORTABLE DAS (Only for pH 110)

The DAS software is designed for pH 110, CON 110 and DO 110 meters to allow you a convenient means of capturing data for future analysis using other software program such as LOTUS 123, EXCEL or DBASE in Windows®. Often one finds it cumbersome to record and transfer data from one media to another before the required processing can be done. With the DAS software, this redundant processing can be eliminated or reduced. To download this software, visit www.eutechinst.com.

10.1 System Requirements

To run the DAS program, the following is required:

1. PC - IBM Compatible XT and above with CD-ROM Drive
2. EGA Monitor and above
3. Windows® Operating System '95 and above
4. Connecting communication RS232C cable

10.2 Loading CyberComm Portable DAS

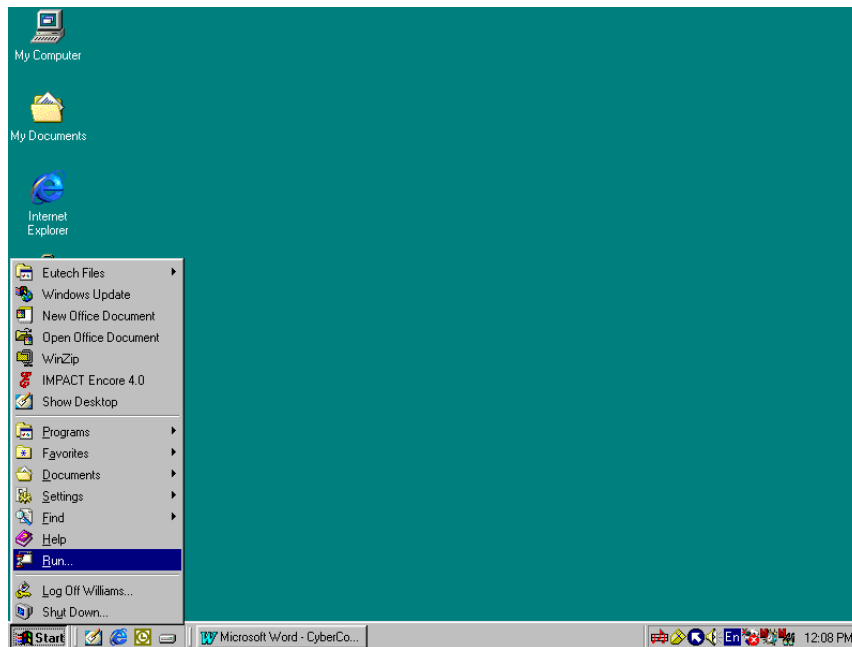

Figure 41: Insert Eutech Instruments' CD-ROM containing Data Acquisition Software (DAS) into your CD-ROM drive. It will Auto Run and let you start loading the software by displaying the screen as in Figure 44. Alternatively, you can also manually load the software by clicking the START button and RUN command.

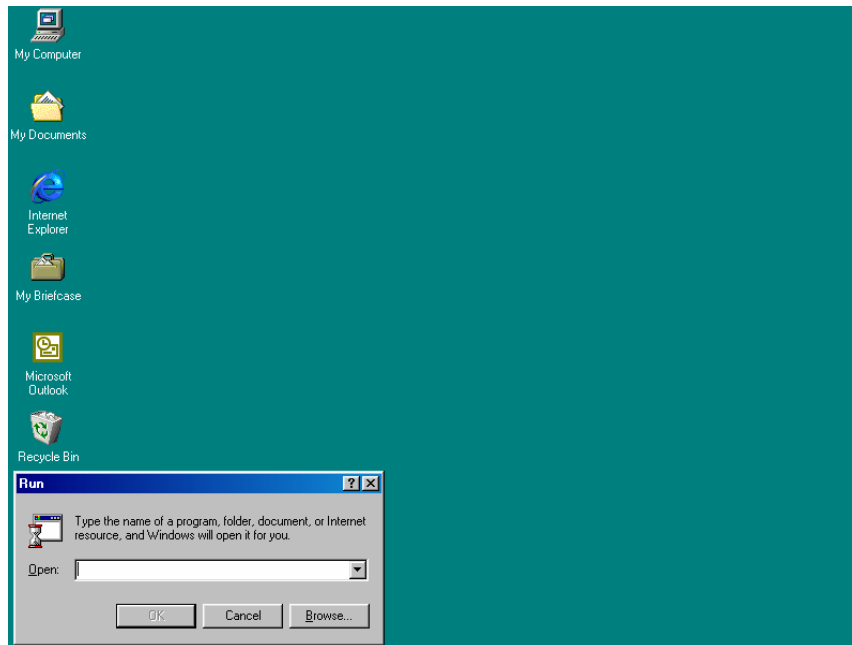

Figure 42: Click on 'Browse' button and locate CD-ROM drive

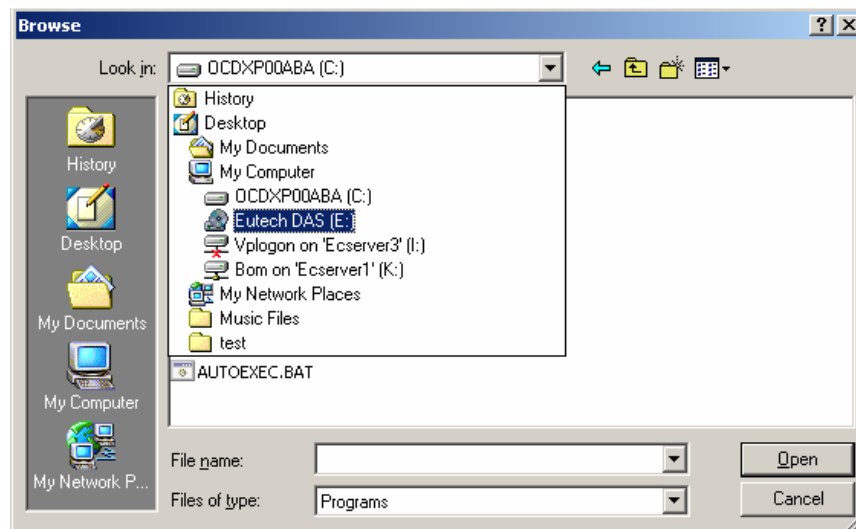

Figure 43: Locate the CyberComm Portable Setup program in the CD-ROM under "Eutech DAS" directory.

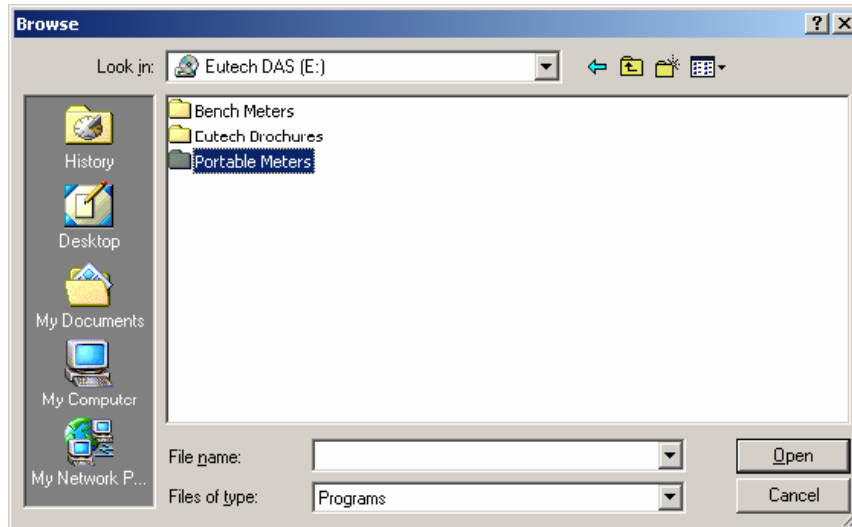

Figure 44: Select 'Portable Meters' directory to go to CyberComm Portable.

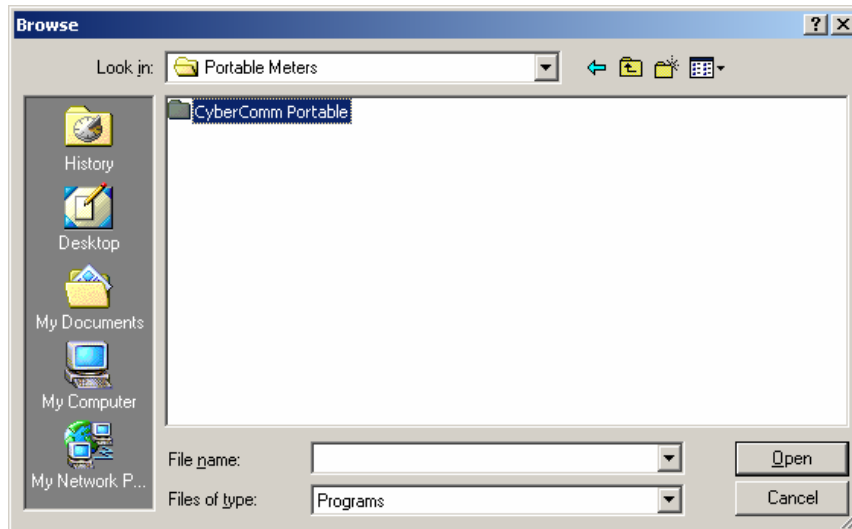

Figure 45: Open 'CyberComm Portable' to enter to the Setup program.

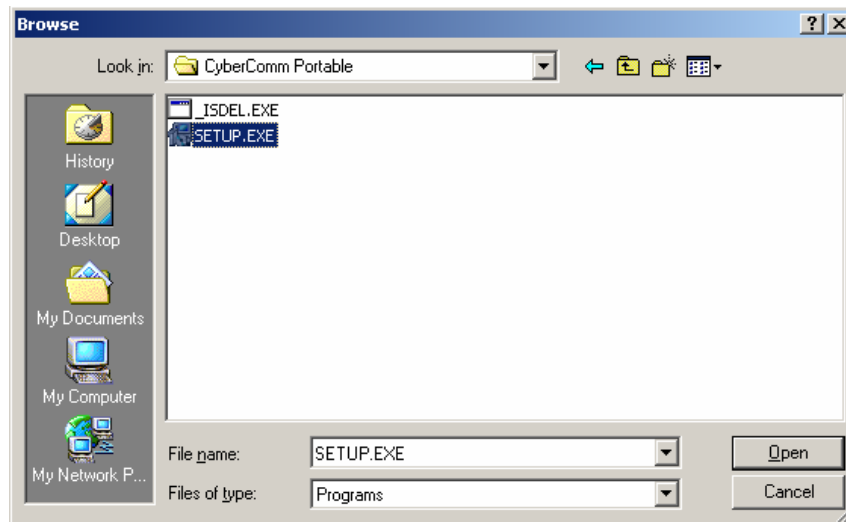

Figure 46: Select "SETUP.EXE" program and click the OPEN button

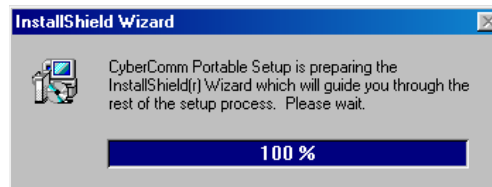

Figure 47: InstallShield Wizard dialog box appears.

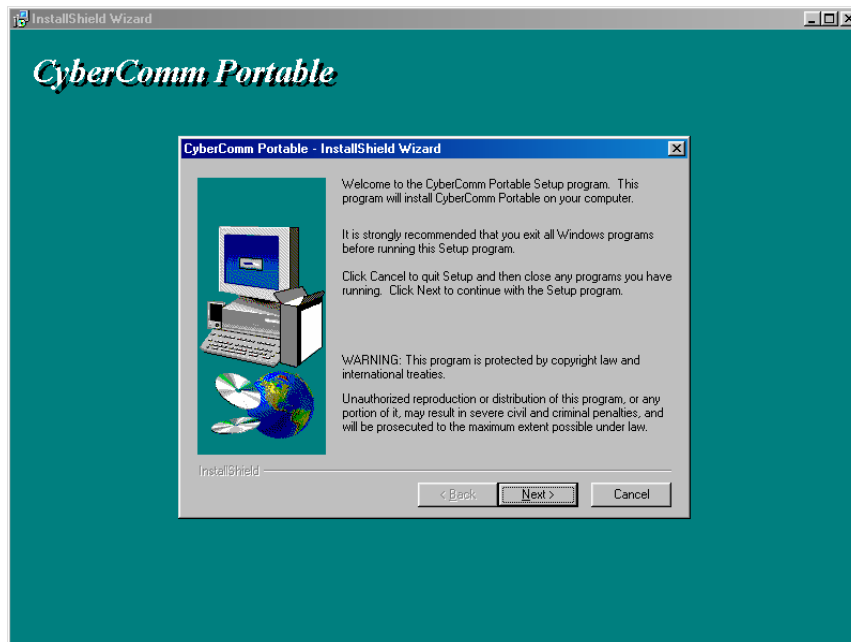

Figure 48: Click on Next button

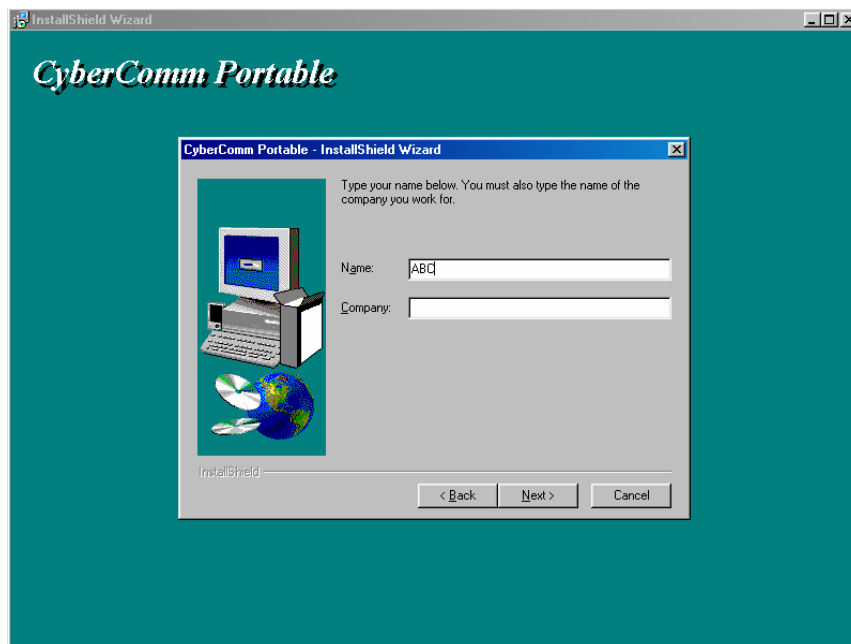

Figure 49: Key in your name and company name and click NEXT button

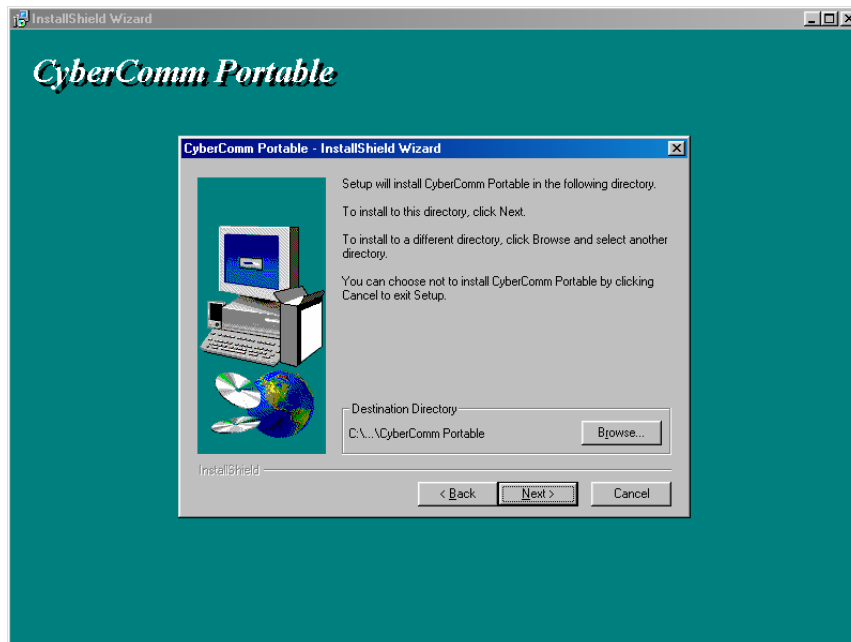

Figure 50: To select another Destination Directory to install the program, click on BROWSE button. Otherwise, click NEXT button.

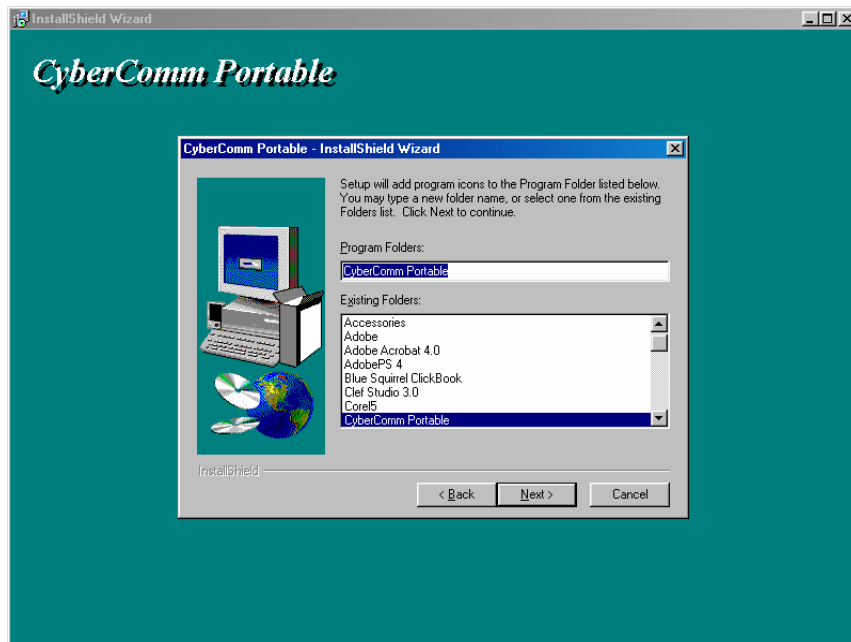

Figure 51: Creating a new program folder. Click on NEXT button.

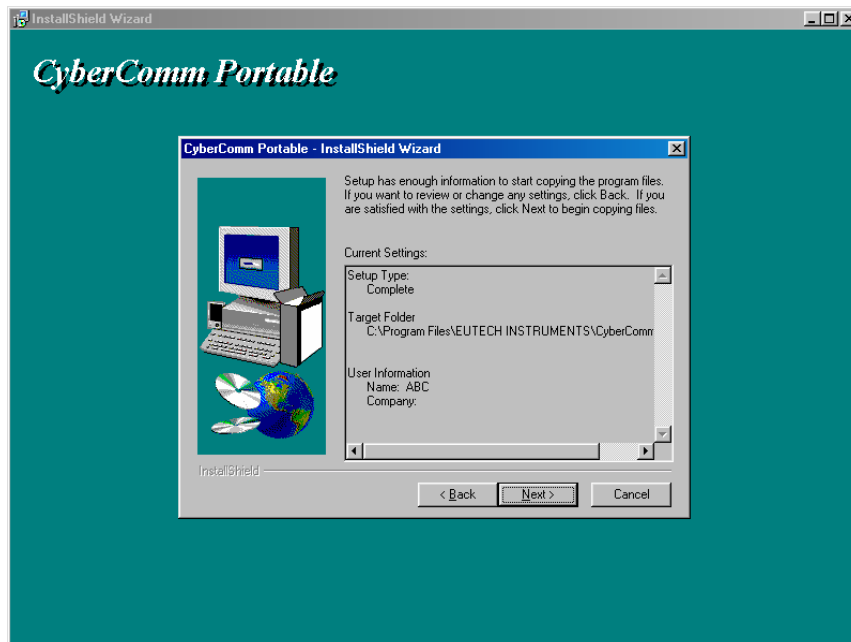

Figure 52: Click on NEXT button.

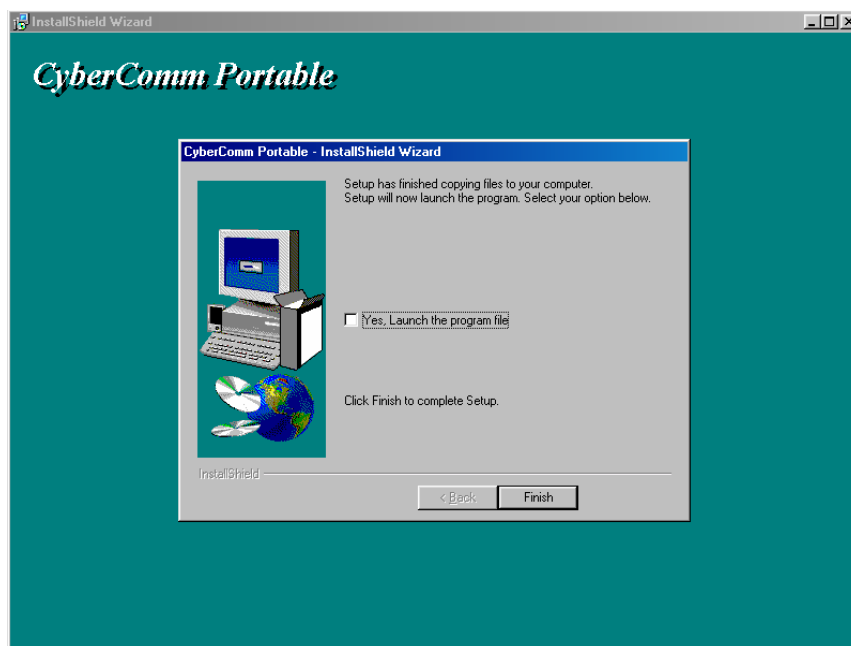

Figure 53: The CyberComm Portable DAS program is fully installed. Click on FINISH button to end installation.

10.3 Running CyberComm Portable

Before running the DAS program, please ensure that the RS232 cable is connected between the computer's serial port and the meter's port. See section 3.4 - Connecting the RS232C Cable (Only for pH 110) on page 9.

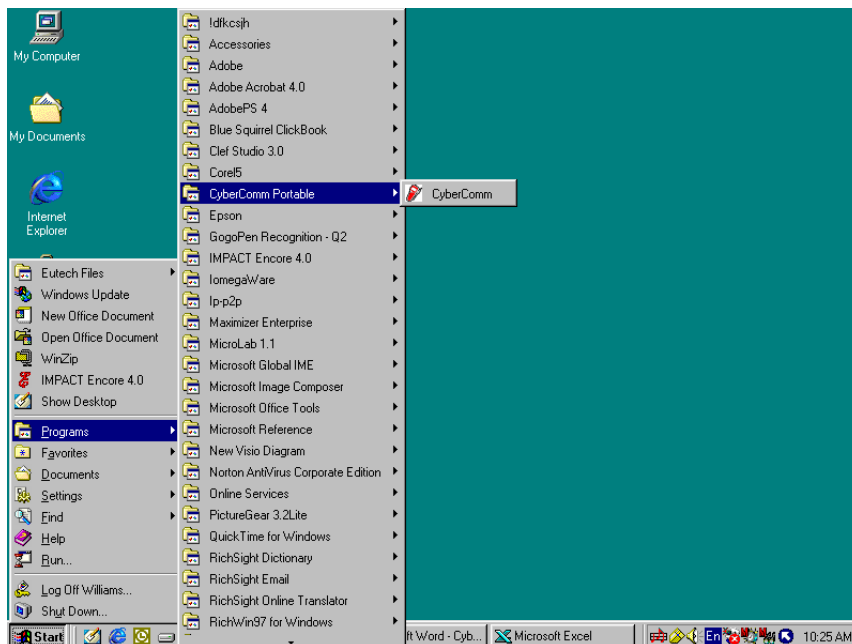

Figure 54: Run the CyberComm Software program

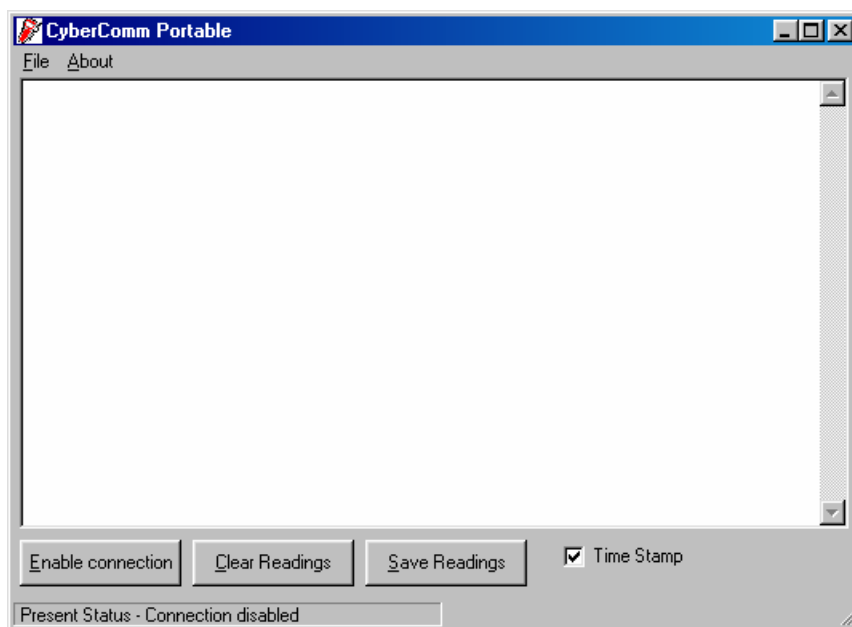

Figure 55: The opening screen will appear as above

10.3.1 Buttons & Check-Box

- Enable Connection - Click this button to enable communication between meter and computer.
- Clear Readings - To clear all data and start all over again.
- Save Readings - To save all data displayed in either *.dat or *.txt format.
- Time Stamp - To include Time and Date stamp when collecting the data. Time and date information comes from the computer.

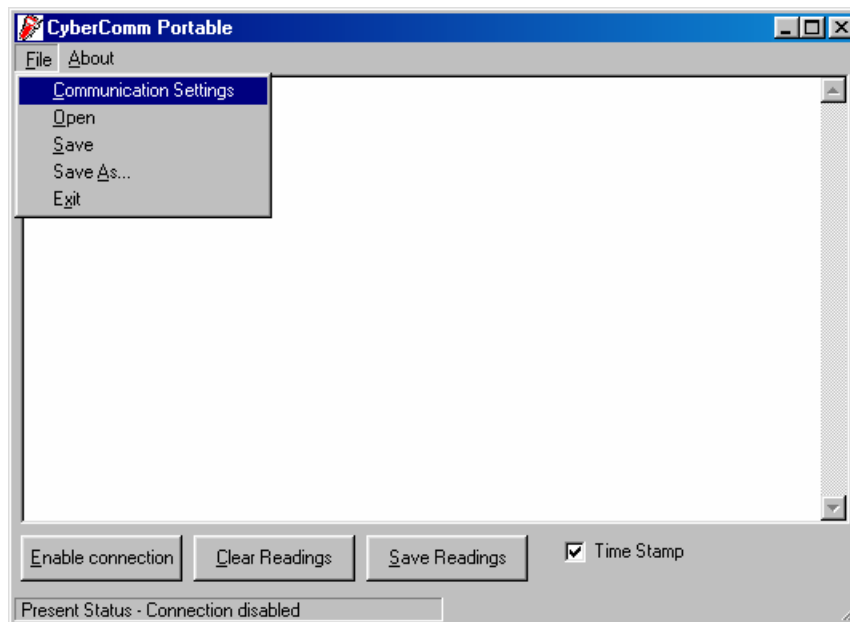

Figure 56: Under File Menu setting, you can change various parameters. Under ABOUT menu, details of Eutech Instruments' contact information, email address and updates are shown.

10.3.2 Menu

- Communication Settings - To set communication port number, baud rate speed, parity and stop bits protocol.
 - Open - To open previously saved data file.
 - Save - To save current data captured.
 - Save As - To save current data set in another format such as *.dat or *.txt.
-

- Exit - To exit from CyberComm Data Acquisition Software program.

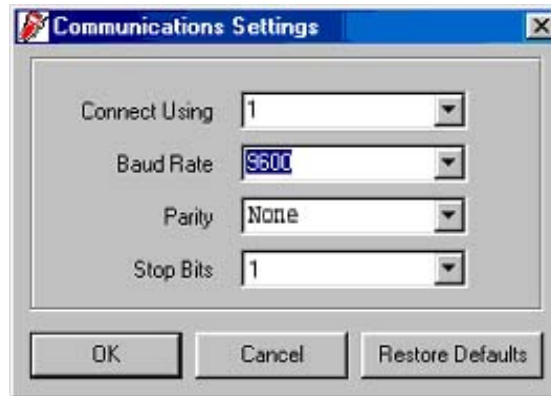

Figure 57: Communication Settings for computer's Com port. It must match with COM port settings on CyberScan pH 110 meter. Please refer to Section 8.1 Using pH 110 Meter With Printer or Computer on page 23 for the settings.

10.3.3 Communication Settings

- Connect Using - For selecting communication port. (Select '1')
- Baud Rate – For selecting baud rate. (Select '9600' bps (bits per second)).
- Parity – For selecting parity. (Select 'None')
- Stop Bits – For selecting stop bits. (Select '1').

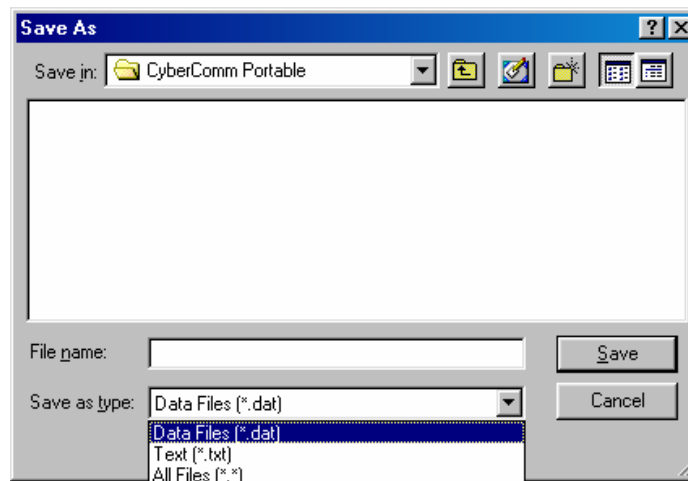

Figure 58: Under SAVE AS menu, you can save your data as *.dat or *.txt formats

10.4 Capturing And Printing Data Into Computer Using Data Acquisition

After matching the Communication Settings between your computer using Data Acquisition program and the pH 110 meter, you can now capture data into your computer for analysis and storage purposes.

1. Ensure the 1-meter RS232 communication cable (Refer to Accessories Section) is connected between the computer and the pH 110 meter's Com port. Refer to section 3.4 "Connecting the RS232C Cable (Only For pH 110)" on page 9 for connection procedure.
2. Switch on the pH 110 meter and run the Data Acquisition software.
3. Click "ENABLE CONNECTION" button.
4. With the pH 110 meter switched on, press the PRINT key to send data to the computer. See Figure 57 below.
5. You can use MODE key on the meter and change to other parameter such as mV or Rel mV and print data accordingly.
6. You can also check off the Time Stamp function, so as to print without the Time and Date information.
7. You can click Clear Readings button to begin another set of measurements, or click Save Readings to store readings for future retrieval.

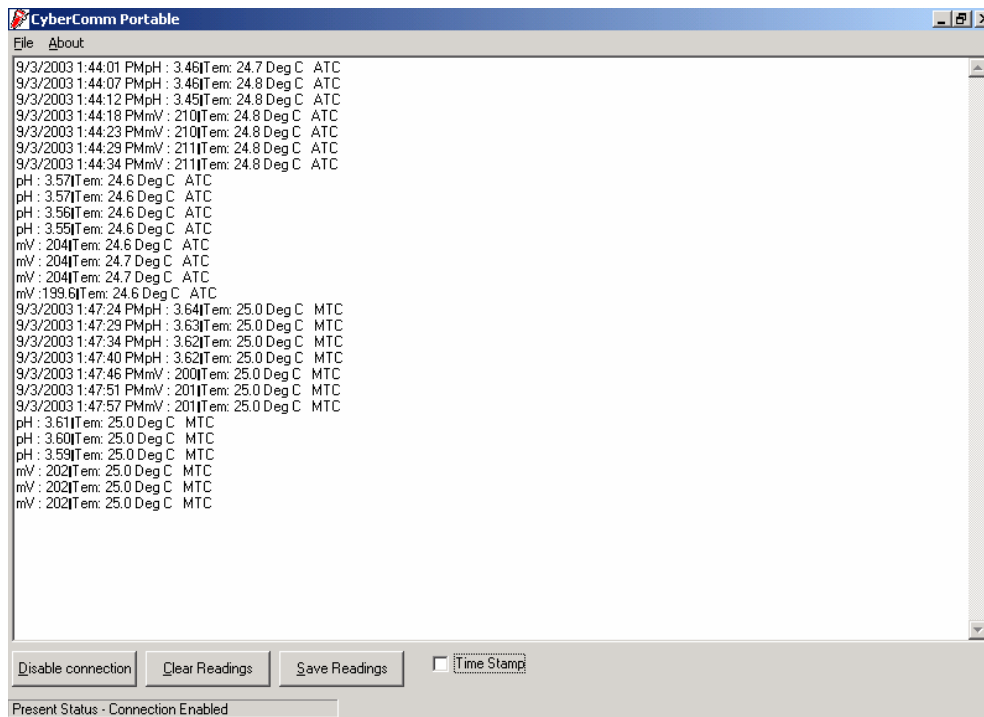

Figure 59: Example of a set of data print in CyberComm Portable DAS

10.5 Trouble-shooting Guide

a) Problem: Unable to PRINT

When press PRINT key on pH 110 meter, nothing is printed.

POSSIBLE CAUSES	SOLUTIONS
You have not "ENABLE CONNECTION" in the Data Acquisition program.	Click on "ENABLE CONNECTION" in the Data Acquisition program.
The "Communication Settings" in the Data Acquisition program is different from meter's setup.	Match the COM port number, baud rate, parity and stop bits information between the Data Acquisition program and the meter.
The COM port number in the Data Acquisition program is wrong.	Change the COM port number (1 or 2) in the Data Acquisition program.
Your computer's COM port setting may be wrong.	Check your computer's hardware settings (through Windows OS, BIOS, or any other OS) and refer to computer's manual or consult with the computer's manufacturer.
You may have used the wrong communication cable.	Make sure you use the RS232C cable supplied together with the meter (Part No. EC-CA01M09F09). Check the RS232C configuration as described in the meter's instruction manual.

To report any bugs, please e-mail to techsupport@eutechinst.com

11 ELECTRODE CARE

11.1 Electrode Maintenance

pH electrodes are susceptible to dirt and contamination and need to be cleaned regularly depending on the extent and condition of use.

11.1.1 Storage

The best results, always keep the pH bulb wet, preferably in electrode storage solution or pH 4 buffers with 1/100 part of saturated KCl. Other pH buffers or tap water are also acceptable storage media, but avoid storage in de-ionised water. The protective electrode storage bottle or rubber cap filled with the buffer solution provides ideal storage for long periods.

11.1.2 After Use

After measurement is complete, follow the sequence elaborated below for storage.

1. Wash the electrode and reference junction in deionised water.
2. Close the refilling hole by returning its rubber sleeve or stopper cap (Necessary for only refillable electrodes).
3. Store the electrode as mentioned above (Storage section 11.1.1), or as recommended by the manufacturer.

11.1.3 Electrolyte Replacement (for refillable electrodes only)

The reference electrolyte needs to be refilled when the electrode has been used for an extended period, or when the internal electrolyte has dried up. To accomplish this, follow the procedure detailed below.

1. Remove the protective rubber cap or sleeve
2. Remove the protective rubber sleeve to expose the filling port of the electrode. Remove the old reference electrolyte with a syringe and a flexible tube.
3. Fill the new reference electrolyte. Add in fresh electrolyte till the level of refilling port. The reference electrolyte depends on your electrode. Use the solution type recommended for your electrode. Replace the rubber sleeve.
4. Reuse the electrode. Rinse the liquid junction with deionised water and tap dry.

NOTE: If these steps fail to restore normal electrode response, you may attempt to

rejuvenate it. (See section 11.4 on Rejuvenation Procedure).

11.2 Electrode Cleaning

Electrodes that are mechanically intact can be restored to normal performance by one or combination of the following procedures.

a) Salt deposits:

Dissolve the deposit by immersing the electrode in tap water for ten to fifteen minutes. Then thoroughly rinse with deionised water.

b) Oil / Grease Films:

Wash electrode pH bulb in a little detergent and water. Rinse electrode tip with deionised water.

c) Clogged Reference Junction:

Heat a dilute KCl solution to 60-80 °C. Place the sensing portion of the pH electrode into the heated KCl solution for approximately 10 minutes. Allow the electrode to cool while immersed in some unheated KCl solution.

d) Protein Deposits:

Prepare a 1% pepsin solution in 0.1M HCl. Allow the electrode to stand in this solution for five to ten minutes. Rinse the electrode with deionised water.

11.3 Electrode Activation

Generally, if the procedure of storage and maintenance had been closely followed, the electrode can be used immediately. However, should the electrode response become sluggish, it may be possible that the bulb has dehydrated. The bulb can be re-hydrated by immersing the electrode in an ideal storage solution (e.g. buffer pH 4 solution) for 10 to 30 minutes. If this fails, the electrode may require re-activation.

At no time should one touch or rub the glass bulb as this causes the build-up of electrostatic charge.

If the above procedure does not re-activate the electrode to acceptable status, try rejuvenating the electrode by following the procedure outlined below.

11.4 Rejuvenation Procedure

1. Dip and stir the electrode in freon or alcohol for 5 minutes.
2. Leave the electrode in tap water for 15 minutes.
3. Dip and stir the electrode in concentrated acid (e.g. HCl, H₂SO₄) for 5 minutes.
4. Repeat Step 2.
5. Dip and stir in strong base (NaOH) for 5 minutes.
6. Leave for 15 minutes in tap water.
7. Test with standard calibration buffer solutions.

CAUTION: Proper eyewear and gloves must be worn when preparing these chemicals and performing this operation.

Finally, test with standard calibration buffer solutions to see if the electrode yields acceptable results. You may repeat steps '3' to '6' again for better response (maximum 3 times). If the response does not improve, then the electrode has completed its useful life. Replace with a new electrode.

12 ERROR MESSAGES

The following table provides a guideline to enable diagnosis of possible problems indicated by the messages generated by the meter. The table also provides possible solutions to the problems encountered.

ERROR MESSAGE	INDICATES	POSSIBLE CAUSE	CORRECTIVE ACTION
Err. Annunciator	Wrong keypad input	Wrong input in selected mode.	Release key. Select valid operations depending on mode.
Secondary Display Toggles Continuously between Calibration Buffer Values, Electrode icon blinks & Err annunciator lights up	Calibration	Incorrect buffer used or contaminated buffer solution	Check if the right buffer was selected or use fresh buffer solution.
Battery icon lights up	Low Battery	Battery power is low	Replace batteries with fresh ones as soon as possible.

13 TROUBLE-SHOOTING

PROBLEM	PROBABLE CAUSE	REMEDIAL ACTION
Nothing is displayed when the ON/OFF key is selected.	<ol style="list-style-type: none"> 1. Batteries not in place. 2. Batteries (+ & - poles) not in correct polarity. 3. Weak batteries. 	<ol style="list-style-type: none"> 1. Insert batteries. 2. Re-insert batteries in the correct polarity. 3. Replace batteries or attach AC adapter.
Unstable reading	<ol style="list-style-type: none"> 1. Insufficient reference electrolyte in electrode. 2. Broken electrode. 3. External "noises" or induction (e.g. electrical 'noise' caused by a nearby motor). 4. Dirty electrode. 	<ol style="list-style-type: none"> 1. Fill electrode with reference electrolyte. 2. Replace electrode. 3. Move or switch off interfering device. 4. Clean the electrode. Rejuvenate if necessary. Recalibrate the meter with the cleaned probe.
Slow responses.	<ol style="list-style-type: none"> 1. Dirty/Oily electrode. 	<ol style="list-style-type: none"> 1. Clean electrode. Rejuvenate if necessary.
Meter is not responding to key press.	<ol style="list-style-type: none"> 1. HOLD mode in operation. 2. Internal program error. 	<ol style="list-style-type: none"> 1. Cancel HOLD mode. 2. Reset all internal programs by re-inserting battery.

14 INFORMATION ON pH MEASUREMENT & ELECTRODE

The previous sections of this manual describe the various features of the instrument and practical aspects of its operation. This section provides a general description of pH measurement principles. It also provides tabulations of pH buffer changes with temperature. Lastly, it includes a list of available accessories.

14.1 pH Measurements

14.1.1 Liquid Junction Potential

The liquid - junction potential is the difference in potential created at the liquid - liquid pHase boundary at the electrode tip, due to dissimilar composition of the test solution and the saturated KCl electrolyte. The sign and size of the liquid - junction potential depends upon the composition of the two solutions, the temperature, and the geometry of the type of junction used.

When two solutions of different compositions come into contact, ion diffusion occurs at the point of contact.

When there is a high liquid junction potential, measured values differ greatly from the true value.

14.1.2 Asymmetry Potential

Within the glass electrode is an internal electrode that contains a reference solution of pH 7. When the electrode is placed in a pH 7 solution, the pH values within and outside the electrode are the same, and no potential ought to be produced. In practice, however, an electric potential called asymmetry potential, is generated.

It has been shown that asymmetry potential varies with the pH of the solution in contact with the glass, with age, with temperature, with the shape of the membrane, with the thickness of the membrane, with impurities in the reference solution, and any imperfections in the glass.

In addition, when the glass membrane dries out, the asymmetry potential increases and leads to measurement errors. That is why it is important to keep the glass hydrated prior to use, by soaking the electrode in a buffered solution or tap water. (Do not use deionised water). The purpose of soaking the glass electrode is to obtain a swollen low resistance glass surface and to stabilise the asymmetry potential of the electrode. This swollen surface is generally spoiled by drying, prolonged immersion in dehydrating solutions or chemical attack, such as etching by alkalis or hydrofluoric acid. Hence, it is necessary to work with a well-soaked glass electrode to ensure a constant asymmetry potential.

14.1.3 pH and Temperature

The electromotive force generated in the glass electrode varies with the temperature of the solution. As a result the response of the pH electrode is subjected to variations in temperature. Automatic Temperature Compensation compensates for this variance.

A solution's temperature dependence varies considerably. Some may show an increase in pH while others a decrease for the same temperature variation. This is why when you are measuring pH values at a particular temperature, even with a pH meter having ATC, you must record the solution's temperature along with the pH value, or the measurement may be meaningless.

Temperature variation also causes variation in liquid junction potential, asymmetry potential, and the pH value of the reference solution. To reduce these factors, it is important to ensure that the temperature of the standard calibrating solution and the sample solution are the same.

14.2 Use of Standard pH Buffers

Standard pH buffer solutions are used to calibrate or standardise a pH meter before you measure the pH of a sample. They serve as reference standards for the basis of comparison between measurements.

The more common standard buffers are the pH 4.01, pH 7.00 and pH 10.01. The others include pH 1.68 and pH 12.45.

For 1-point calibration, you only need a general pH value. Use a standard buffer of pH 7.00 or a standard buffer whose pH value is close to that of the sample.

2-point calibration is used when you know that the sample is acidic or basic.

- For acidic sample: use standard buffers of pH 7.00 and pH 4.01
- For basic sample: use standard buffers of pH 7.00 and pH 10.01

3-point calibration is necessary when the sample's pH is completely unknown. pH 7.00, pH 4.01 and pH 10.01 standard buffers should be used.

14.3 Standard pH Buffers

The following table shows the various pH values at different temperature of the solution during calibration.

Temperature (°C)	pH 1.68 (oxalate)	pH 4.01 (phthalate)	pH 7.00 (neutral Phosphate)	pH 10.01 (carbonate)	pH 12.45 (Saturated Calcium Hydroxide Solution)
0	1.67	4.01	7.12	10.32	13.43
5	1.67	4.01	7.09	10.25	13.21
10	1.67	4.00	7.06	10.18	13.00
15	1.67	4.00	7.04	10.12	12.81
20	1.68	4.00	7.02	10.06	12.63
25	1.68	4.01	7.00	10.01	12.45
30	1.69	4.01	6.99	9.97	12.29
35	1.69	4.02	6.98	9.93	12.13
40	1.70	4.03	6.97	9.89	11.99
45	1.70	4.04	6.97	9.86	11.84
50	1.71	4.06	6.97	9.83	11.70
55	-	4.08	6.97	9.81	-
60	-	4.10	6.98	9.79	-
70	-	4.12	6.99	9.76	-
80	-	4.16	7.00	9.74	-
90	-	4.20	7.02	9.73	-

15 LIST OF ACCESSORIES

15.1 Replacement Meter and Meter accessories

Eutech Instruments

Item	Eutech Instruments Order Code
CyberScan pH 11 Portable pH/mV Meter with 2 electrode holders 15X000700, temperature probe EC-PH5-TEM01P	EC-PH11/01
CyberScan pH 110 Portable pH/mV/RS232 Meter with 2 electrode holders 15X000700, PC-based DAS, RS232C cable & temperature probe EC-PH5-TEM01P	EC-PH110/01
CyberScan pH 11 Portable pH/mV Meter with pH electrode EC-FC72522-01B, 2 electrode holders 15X000700, temperature probe EC-PH5-TEM01P & pH carrying kit set EC-PHWP-KIT	EC-PH11/02K
CyberScan pH 110 Portable pH/mV/RS232 Meter with pH electrode EC-FC72522-01B, 2 electrode holders 15X000700, temperature probe EC-PH5-TEM01P, PC-based DAS, RS232C cable & pH carrying kit set EC-PHWP-KIT	EC-PH110/02K
Temperature probe for pH 11 and pH 110 meters.	EC-PH5-TEM01P
Electrode Holder for probes and electrodes (12 mm diameter)	15X000700
General purpose epoxy-body pH combination electrode, single-junction, 12x110 mm, 1-m cable length.	EC-FC72521-01B
General purpose epoxy-body pH combination electrode, double-junction, 12x110 mm, 1-m cable length.	EC-FC72522-01B
"3-in-1" pH/Temperature (ATC) combination epoxy-body electrode, single-junction, 12x110 mm, 1-m cable length.	EC-FC73528-01B
Combination ORP electrode, epoxy-body, single-junction, 12x110 mm, 1-m cable length	EC-FC79601-01B
Combination ORP electrode, epoxy-body, double-junction, 12x110 mm, 1-m cable length	EC-FC79602-01B
RS232 Communication Cable: 9-pin male to 9-pin female connector, 1m cable length	EC-CA01M09F09
Serial Impact Micro-Printer: Dot-matrix, paper-roll portable printer with 25-pin female connector, with a roll of paper and 110/120 VAC power adapter provided	EC-MICROPRNTR01
Serial Impact Micro-Printer: Dot-matrix, paper-roll portable printer with 25-pin female connector, with a roll of paper and 220/230 VAC power adapter provided	EC-MICROPRNTR02
pH Carrying Kit Set - Plastic Carrying Case comprises 1 x pH 4.01, pH 7.00, pH 10.01 buffer solutions (60 ml) and 1 x empty rinse water bottle (480 ml)	EC-PH-WPKIT
110/120 VAC Power Adapter (50/60 Hz) 2-flat pin US type, 9 VDC 500mA (for standard portable meters)	EC-120-ADA
220/230 VAC Power Adapter (50/60 Hz) 2-round pin Euro type, 9 VDC 500mA (for standard portable meters)	EC-220-ADA

15.2 Oakton Instruments

Item	Oakton Instruments Order Code
CyberScan pH 11 Portable pH/mV Meter with 2 electrode holders 15X000700, temperature probe EC-PH5-TEM01P	35614-22
CyberScan pH 11 Portable pH/mV Meter with pH electrode EC-FC72522-01B, 2 electrode holders 15X000700, temperature probe EC-PH5-TEM01P & pH carrying kit set EC-PHWP-KIT	35614-20
CyberScan pH 110 Portable pH/mV/RS232 Meter with 2 electrode holders 15X000700, PC-based DAS, RS232C cable & temperature probe EC-PH5-TEM01P	35615-22
CyberScan pH 110 Portable pH/mV/RS232 Meter with pH electrode EC-FC72522-01B, 2 electrode holders 15X000700, temperature probe EC-PH5-TEM01P, PC-based DAS, RS232C cable & pH carrying kit set EC-PHWP-KIT	35615-20
Temperature probe for pH 11 and pH 110 meters.	35613-05
Electrode Holder for probes and electrodes (12 mm diameter)	35615-06
General purpose epoxy-body pH combination electrode, single-junction, 12x110 mm, 1-m cable length.	59001-65
General purpose epoxy-body pH combination electrode, double-junction, 12x110 mm, 1-m cable length.	35641-51
"All-in-1" pH/Temperature (ATC) combination epoxy-body electrode, single-junction, 12x110 mm, 1-m cable length.	35811-71
"All-in-1" pH/Temperature (ATC) combination epoxy-body electrode, double-junction, 12x110 mm, 1-m cable length.	35811-72
Combination ORP electrode, epoxy-body, single-junction, 12x110 mm, 1-m cable length	35649-50
Combination ORP electrode, epoxy-body, double-junction, 12x110 mm, 1-m cable length	35649-51
RS232 Communication Cable: 9-pin male to 9-pin female connector, 1m cable length.	35615-09
Serial Impact Micro-Printer: Dot-matrix, paper-roll portable printer with 25-pin female connector, with a roll of paper and 110/120 VAC power adapter provided	35622-00
Serial Impact Micro-Printer: Dot-matrix, paper-roll portable printer with 25-pin female connector, with a roll of paper and 220/230 VAC power adapter provided	35622-05
Soft belt-loop carrying case	35615-75
pH kit for pH 11 & pH 110 meter – Hard plastic carrying case comprises of 1 pc deionised water bottle (480 ml, empty), 1 x pH 4.01, pH 7.00 & pH 10.01 buffer pouches (20-ml), 4 pcs calibration jars (30-ml, empty), & 1 pc rinse/waste water bottle (480-ml, empty).	35614-79 (35632-98 + five of each buffer pouch included)
110/120 VAC Power Adapter (50/60 Hz) 2-flat pin US type, 9 VDC 500mA (for standard portable meters)	35615-07
220/230 VAC Power Adapter (50/60 Hz) 2-round pin Euro type, 9 VDC 500mA (for standard portable meters)	35615-08

15.3 Calibration Solutions

Item	Eutech Instruments Order Code	Oakton Instruments Order Code
pH 4.01 buffer solution, 480 ml bottle (1 pint)	EC-BU-4BT	00654-00
pH 7.00 buffer solution, 480 ml bottle (1 pint)	EC-BU-7BT	00654-04
pH 10.01 buffer solution, 480 ml bottle (1 pint)	EC-BU-10BT	00654-08
pH 4.01 buffer sachets, 20 ml x 20 pcs.	EC-BU-4BS	35653-01
pH 7.00 buffer sachets, 20 ml x 20 pcs.	EC-BU-7BS	35653-02
pH 10.01 buffer sachets, 20 ml x 20 pcs.	EC-BU-10BS	35653-03
pH De-ionised water rinse sachets, 20 ml x 20 pcs	EC-RIN-WT	35653-00
pH sachet assortment pack – 5 each of pH 4.01, pH 7.00, pH 10.01 and de-ionised water sachets per box.	EC-AST-PK	35653-04
Protein cleaning solution for pH electrode	EC-DPC-BT	00653-06
Storage solution for pH electrode	EC-RE-005	00653-04

Note: pH buffer solutions (480-ml bottle) have ± 0.01 pH accuracy at 25 °C.

Sachets are individually sealed, single use pouch containing 20 ml of fresh, contamination free calibration solution. pH buffer sachets have ± 0.01 pH accuracy at 25°C.

16 FACTORY DEFAULT SETTINGS

16.1 pH 11 Factory Default Settings

PROGRAM	FUNCTION	PARAMETER OPTING KEYS	PARAMETER OPTIONS	DEFAULT SETTING
P 1.0	Unit Configuration	<i>Parameter Title Only</i>	<i>Parameter Title Only</i>	
P 1.1	Ready Indicator	MI/▲; MR/▼	ON ; OFF,	ON
P 1.2	Select pH buffer option	MI/▲; MR/▼	USA, nSt,	USA
P 1.3	Number of calibration points	MI/▲; MR/▼	3 P, 4 P, 5 P, 2 P	3 P
P 2.0	View previous calibration data	<i>Parameter Title Only</i>	<i>Parameter Title Only</i>	
P 2.1	First calibration point	<i>Viewing Only</i>	<i>Viewing Only</i>	---
P 2.2	Second calibration point	<i>Viewing Only</i>	<i>Viewing Only</i>	---
P 2.3	Third calibration point	<i>Viewing Only</i>	<i>Viewing Only</i>	---
P 2.4	Fourth calibration point	<i>Viewing Only</i>	<i>Viewing Only</i>	---
P 2.5	Fifth calibration point	<i>Viewing Only</i>	<i>Viewing Only</i>	---
P 3.0	View electrode data	<i>Parameter Title Only</i>	<i>Parameter Title Only</i>	
P 3.1	Electrode offset (pH mode)	<i>Viewing only</i>	<i>Viewing only</i>	---
P 3.2	pH electrode slope	<i>Viewing only</i>	<i>Viewing only</i>	---
P 4.0	Select auto power on/off	MI/▲; MR/▼	YES, nO	YES
P 5.0	Reset to factory default	<i>Parameter Title Only</i>	<i>Parameter Title Only</i>	
P 5.1	Reset pH or ORP calibrated data	MI/▲; MR/▼	nO, YES	nO
P 5.2	User reset to factory default	MI/▲; MR/▼	nO, YES	nO
P 6.0	Memory clear	MI/▲; MR/▼	nO, YES	nO

NOTE: The HOLD/ENTER key is used to confirm every parameter opted. The CAL/MEAS on the other hand will escape the set up operation to return to the measurement mode.

16.2 pH 110 Factory Default Settings

PROGRAM	FUNCTION	PARAMETER OPTING KEYS	PARAMETER OPTIONS	DEFAULT SETTING
P 1.0	Unit Configuration	<i>Parameter Title Only</i>	<i>Parameter Title Only</i>	
P 1.1	Ready Indicator	MI/▲; MR/▼	ON ; OFF, HOLD	ON
P 1.2	Select pH buffer option	MI/▲; MR/▼	USA, nSt, dn, PUr	USA
P 1.3	Number of calibration points	MI/▲; MR/▼	3 P, 4 P, 5 P, 2 P	3 P
P 1.4	Select °C or °F	MI/▲; MR/▼	C, F	C
P 2.0	View previous calibration data	<i>Parameter Title Only</i>	<i>Parameter Title Only</i>	
P 2.1	First calibration point	<i>Viewing Only</i>	<i>Viewing Only</i>	---
P 2.2	Second calibration point	<i>Viewing Only</i>	<i>Viewing Only</i>	---
P 2.3	Third calibration point	<i>Viewing Only</i>	<i>Viewing Only</i>	---
P 2.4	Fourth calibration point	<i>Viewing Only</i>	<i>Viewing Only</i>	---
P 2.5	Fifth calibration point	<i>Viewing Only</i>	<i>Viewing Only</i>	---
P 2.6	Sixth calibration point	<i>Viewing Only</i>	<i>Viewing Only</i>	---
P 3.0	View electrode data	<i>Parameter Title Only</i>	<i>Parameter Title Only</i>	
P 3.1	Electrode offset (pH mode)	<i>Viewing only</i>	<i>Viewing only</i>	---
P 3.1	Electrode offset (mV mode)	<i>Viewing only</i>	<i>Viewing only</i>	0.0
P 3.2	pH electrode slope	<i>Viewing only</i>	<i>Viewing only</i>	---
P 4.0	Select auto power on/off	MI/▲; MR/▼	YES, nO	YES
P 5.0	Reset to factory default	<i>Parameter Title Only</i>	<i>Parameter Title Only</i>	
P 5.1	Reset pH or ORP calibrated data	MI/▲; MR/▼	nO, YES	nO
P 5.2	User reset to factory default	MI/▲; MR/▼	nO, YES	nO
P 6.0	Memory clear	MI/▲; MR/▼	nO, YES	nO

NOTE: The HOLD/ENTER key is used to confirm every parameter opted. The CAL/MEAS on the other hand will escape the set up operation to return to the measurement mode.

17 SPECIFICATIONS

MODEL NO.	pH 11	pH 110
pH Range	-2.00 to 16.00 pH	-2.00 to 16.00 pH
Resolution	0.01 pH	0.01 pH
Accuracy	± 0.01 pH	± 0.01 pH
Slope Range	80% to 120%	80% to 120%
Millivolt Range	-1999 to +1999 mV	-1999 to +1999 mV
Resolution	0.1 mV (between ±199.9 mV) 1 mV (beyond ±199.9 mV)	0.1 mV (between ±199.9 mV) 1 mV (beyond ±199.9 mV)
Accuracy	± 0.2 mV (between ±199.9 mV) ± 2.0 mV (beyond ±199.9 mV)	± 0.2 mV (between ±199.9 mV) ± 2.0 mV (beyond ±199.9 mV)
Relative mV Range	- none -	+ 1999 to -1999 mV
Resolution	- none -	0.1 mV (between ±199.9 mV) 1 mV (beyond ±199.9 mV)
Accuracy	- none -	0.2 mV (between ±199.9 mV) 2.0 mV (beyond ±199.9 mV)
Temperature Range	-10.0 to 110.0 °C	-10.0 to 110.0 °C (14 to 230 °F)
Resolution	0.1 °C	0.1 °C (0.1 °F from 14.0 °F to 199.9 °F) & (1 °F from 200 °F to 230 °F)
Accuracy	± 0.5 °C	± 0.5 °C (± 0.9 °F)
Temperature Compensation	Automatic / Manual (0 to 100 °C)	Automatic / Manual (0 to 100 °C)
No. Of Calibration Points	2 to 5 points	2 to 6 points
No. Of pH Buffer Values	USA: pH 1.68, 4.01, 7.00, 10.01 & 12.45 NIST: pH 1.68, 4.01, 6.86, 9.18, & 12.45	USA: pH 1.68, 4.01, 7.00, 10.01 & 12.45 NIST: pH 1.68, 4.01, 6.86, 9.18, & 12.45 DIN: pH 1.09, 3.06, 4.65, 6.79, 9.23 & 12.75 PWB: pH 4.10 and 6.97
pH Buffer Options	USA & NIST	USA, NIST, DIN & PWB
Relative mV functions	No	Yes
Relative mV Offset Display	No	Yes
pH Slope Display	Yes	Yes
pH Offset Display	Yes	Yes
Memory	50 data sets	100 data sets
Outputs	None	RS232C
Auto Off	Selectable	Selectable
Auto Off Time	20 minutes after last key operation	20 minutes after last key operation
Averaging/Stability (READY)	Selectable	Selectable
Display	Custom Dual LCD	Custom Dual LCD
Hold Function	Yes	Yes
Auto Hold function	No	Selectable
Inputs	BNC, 2.5 mm phono jack, power jack	BNC, 2.5 mm phono jack, power jack
Output	No	RS232C
Power Requirements	4 'AAA' Batteries; AC/DC Adapter 9 V, 200 mA	4 'AAA' Batteries; AC/DC Adapter 9 V, 200 mA
Battery Life	> 700 hrs (Alkaline Batteries)	> 700 hrs (Alkaline Batteries)
Environmental Requirements	0 to 50 °C (32 to 122 °F)	0 to 50 °C (32 to 122 °F)
Weight & Dimensions	Meter: 18.7 x 9 x 4 cm; 290 g Boxed: 24 x 23 x 7 cm; 650 g	Meter: 18.7 x 9 x 4 cm; 290 g Boxed: 24 x 23 x 7 cm; 650 g

Note: In strong electromagnetic environment, a deviation of up to 3 % of reading may be noticed.

18 WARRANTY

This meter is supplied with a three-year warranty, six-month warranty for probe against significant deviations in material and workmanship.

If repair or adjustment is necessary and has not been the result of abuse or misuse within the designated period, please return – freight pre-paid – and correction will be made without charge. Eutech Instruments/ Oakton Instruments will determine if the product problem is due to deviations or customer misuse.

Out of warranty products will be repaired on a charged basis.

Exclusions

The warranty on your instrument shall not apply to defects resulting from:

- Improper or inadequate maintenance by customer
- Unauthorised modification or misuse
- Operation outside of the environment specifications of the products

19 RETURN OF ITEMS

Authorisation must be obtained from our Customer Service Department or authorised distributor before returning items for any reason. A “Return Goods Authorisation” (RGA) form is available through our Authorised Distributor. Please include data regarding the reason the items are to be returned. For your protection, items must be carefully packed to prevent damage in shipment and insured against possible damage or loss. Eutech Instruments/ Oakton Instruments will not be responsible for damage resulting from careless or insufficient packing. A restocking charge will be made on all unauthorised returns.

NOTE:

Eutech Instruments Pte Ltd/ Oakton Instruments reserve the right to make improvements in design, construction, and appearance of products without notice.

NOVA-TECH
INTERNATIONAL

800 Rockmead Dr Ste 102 • Houston, TX 77339-2112
Tel: (281) 359-8538 • Toll Free Tel: (866) 433-6682
Fax: (281) 359-0084 • Toll Free Fax: (866) 433-6684
sales@novatech-usa.com • www.novatech-usa.com