

16. Warranty

OAKTON warrants this meter to be free from significant deviations in material and workmanship for a period of three years from date of purchase. OAKTON warrants this probe to be free from significant deviations in material and workmanship for a period of six months from date of purchase. If repair or adjustment is necessary and has not been the result of abuse or misuse within the warranted time period, please return—freight prepaid—and correction will be made without charge. OAKTON alone will determine if the product problem is due to deviations or customer misuse.

Out-of-warranty products will be repaired on a charge basis.

17. Return of items

Authorization must be obtained from our Customer Service Department before returning items for any reason. When applying for authorization, please include data regarding the reason the items are to be returned. For your protection, items must be carefully packed to prevent damage in shipment and insured against possible damage or loss. We will not be responsible for damage resulting from careless or insufficient packing. A restocking charge will be made on all unauthorized returns.

NOTE: We reserve the right to make improvements in design, construction, and appearance of products without notice.

NOVA-TECH
INTERNATIONAL
800 Rockmead Dr Ste 102 • Houston, TX 77339-2112
Tel: (281) 359-8538 • Toll Free Tel: (866) 433-6682
Fax: (281) 359-0084 • Toll Free Fax: (866) 433-6684
sales@novatech-usa.com • www.novatech-usa.com

00702-89

OAKTON®

OPERATING INSTRUCTIONS

OAKTON® 35631-00

Portable Waterproof pH/CON 300 Meter

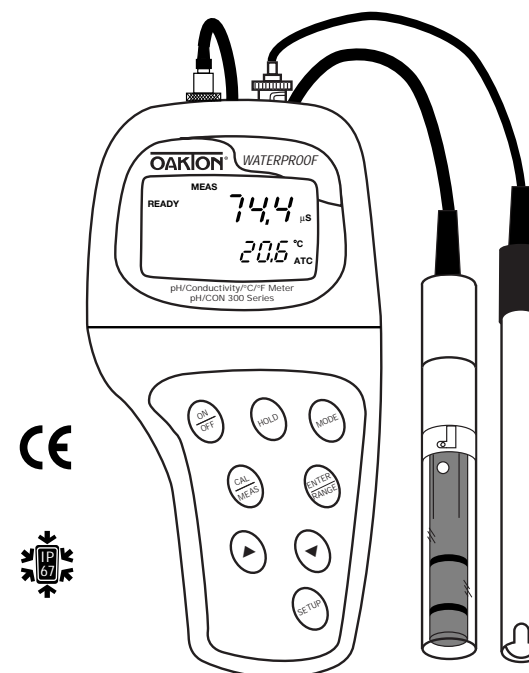

R1 Printed in the U.S.A. 10/00

OAKTON®

Table of Contents

1. Introduction.....	4	6.5 <u>Program 4.0</u> : Resetting to factory default settings (pH).....	31
2. Display and keypad functions	5-6	6.6 <u>Program 5.0</u> : Viewing previous conductivity/TDS calibration data.....	32
2.1 Display	5	6.7 <u>Program 6.0</u> : Viewing conductivity/TDS probe data (effective cell constant)	33
2.2 Keypad.....	6	6.8 <u>Program 7.0</u> : Conductivity/TDS measurement configuration	34-37
3. Preparation	7-9	P7.1 Selecting Ready indicator/auto endpoint function.....	34
3.1 Inserting the batteries	7	P7.2 Selecting °C or °F	35
3.2 Probe information	8-9	P7.3 Selecting automatic or manual temperature compensation.....	36
4. Calibration	10-16	P7.4 Setting the TDS factor	37
4.1 Important information on meter calibration	10	6.9 <u>Program 8.0</u> : Temperature settings.....	38-39
4.2 Preparing the meter for calibration.....	10	P8.1 Setting the temperature coefficient	38
4.3 pH calibration.....	11-12	P8.2 Selecting the normalization temperature	39
4.4 Conductivity and TDS calibration	13-15	6.10 <u>Program 9.0</u> : Resetting to factory default settings (conductivity/TDS)	40
4.5 Temperature calibration	16	7. Probe care and maintenance.....	41-42
5. Measurement	17-22	7.1 pH electrode care	40-41
5.1 Taking pH measurements.....	17	7.2 Conductivity probe care.....	41
5.2 Taking conductivity or TDS measurements.....	18	8. Troubleshooting.....	43
5.3 HOLD function / Ready indicator / Auto endpoint	19	9. Error Messages	44
5.4 Using manual ranging function: conductivity/TDS	20	10. Specifications	45
5.5 Selecting manual temperature compensation: conductivity/TDS.....	21	11. Accessories	46-47
5.6 Selecting the manual temperature compensation value	22	12. Appendix 1: conductivity to TDS conversion factors.....	48
6. Advanced setup functions	23-40	13. Appendix 2: calculating TDS conversion factors.....	49
6.1 Advanced setup mode overview.....	24-25	14. Appendix 3: calculating temperature coefficients	50
pH	24	15. Appendix 4: meter factory default settings	51
Conductivity/TDS	25	16. Warranty.....	52
6.2 <u>Program 1.0</u> : Viewing previous pH calibration data	26	17. Return of Items.....	52
6.3 <u>Program 2.0</u> : Viewing pH electrode data (slope and offset).....	27		
6.4 <u>Program 3.0</u> : pH measurement configuration	28-30		
P3.1 Selecting Ready indicator/auto endpoint function.....	28		
P3.2 Selecting number of pH calibration points.....	29		
P3.3 Selecting °C or °F	30		

1. Introduction

Thank you for selecting an OAKTON meter. This OAKTON portable meter is a microprocessor-based instrument that measures pH, conductivity, TDS and temperature! Your meter has many user-friendly features, all of which are accessible through the membrane keypad.

Your meter includes a single-junction pH electrode, a combination conductivity/temperature probe, and batteries. Please read this manual thoroughly before operating your meter.

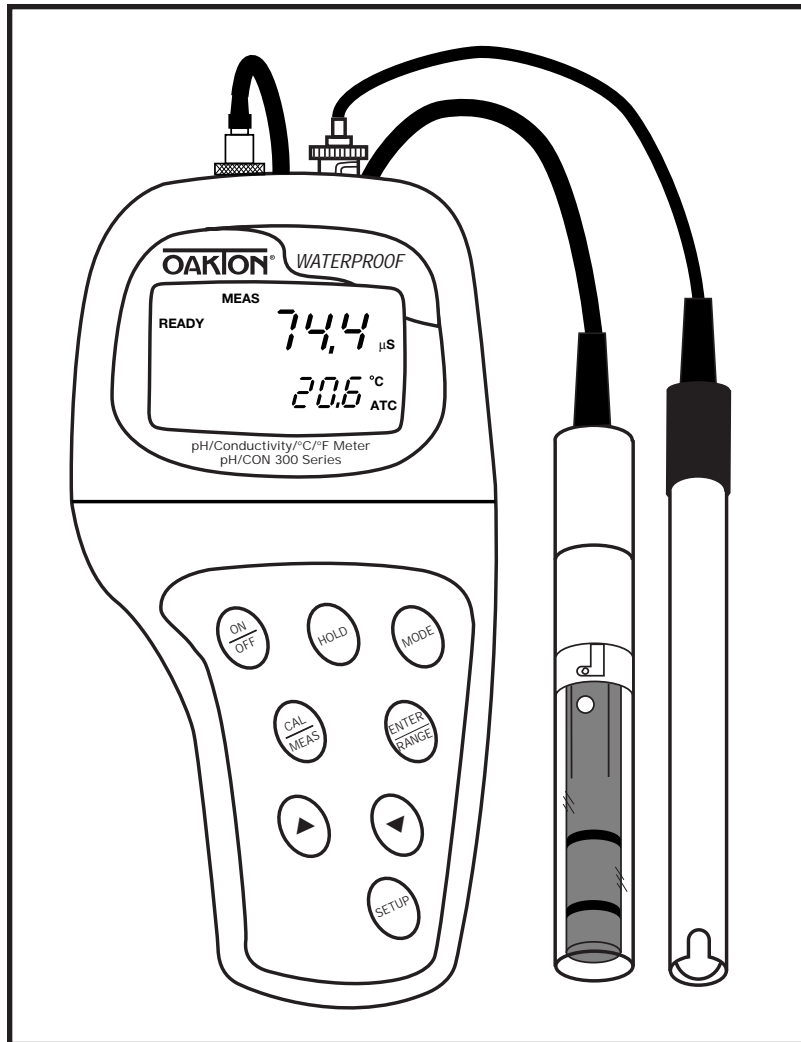

2. Display and Keypad Functions

2.1 Display

The LCD has a primary and secondary display.

- The primary display shows the measured pH or conductivity reading.
- The secondary display shows the temperature of the reading.

The display also shows error messages, keypad functions and program functions.

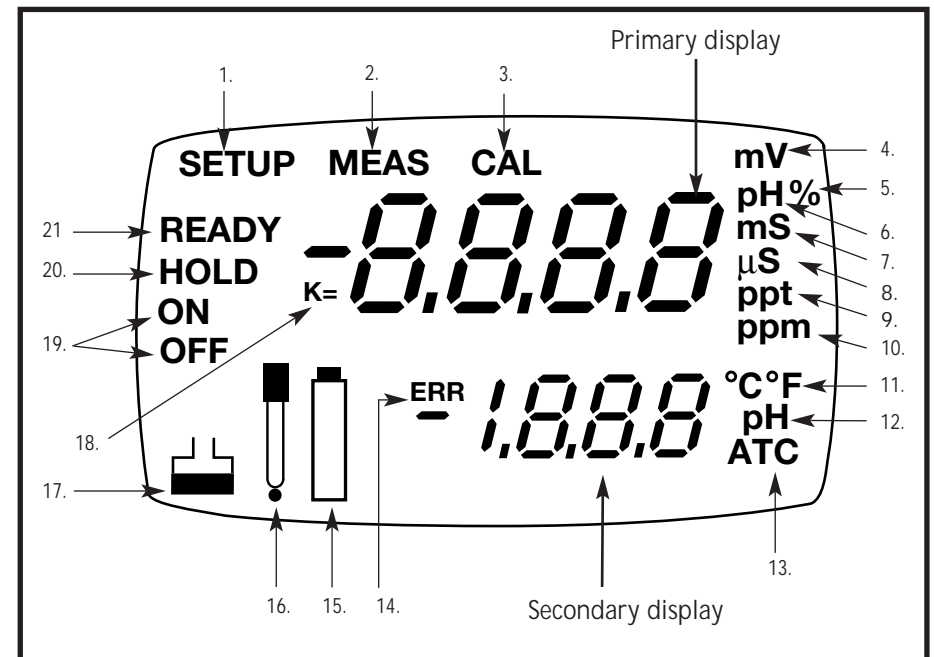

- | | | |
|-------------------------------|--|-----------------------------|
| 1. SETup mode indicator | 9. Parts per thousand indicator | 14. ERRor indicator |
| 2. MEASurement mode indicator | 10. Parts per million indicator | 15. Low battery indicator |
| 3. CALibration indicator | 11. Temperature indicators | 16. Probe indicator |
| 4. mV indicator | 12. pH setup indicator | 17. Calibration indicator |
| 5. % indicator | 13. Automatic Temperature Compensation indicator | 18. Cell constant indicator |
| 6. pH measurement indicator | | 19. ON/OFF indicator |
| 7. Millisiemens indicator | | 20. HOLD indicator |
| 8. Microsiemens indicator | | 21. READY indicator |

2.2 Keypad

The large membrane keypad makes the instrument easy to use. Each button, when pressed, has a corresponding graphic indicator on the LCD.

ON/OFF.....Powers and shuts off the meter.

HOLDFreezes the measured reading. To activate, press HOLD while in measurement mode. To release, press HOLD again.

NOTE: When auto endpoint feature is switched on, meter automatically holds reading after 5 seconds of stability. The HOLD indicator appears on the display. Press HOLD to release auto endpoint feature.

MODE.....Selects the measurement parameter. Press MODE to toggle between pH, conductivity and TDS readings. In calibration mode, press MODE to access temperature calibration.

CAL/MEAS.....Toggles user between Calibration and Measurement mode. For example, if you are in pH measurement mode, press CAL/MEAS to enter pH calibration mode.

NOTE: Temperature calibration is available from calibration mode; see page 16 for directions.

In advanced set-up mode: Press CAL/MEAS to return to main menu from sub menus. Press CAL/MEAS again to return to measurement mode from main menu.

ENTERPress to confirm values in Calibration mode and to confirm selections in Setup mode.

RANGE.....Press to switch to manual ranging in Conductivity (or TDS) mode.

▲ ▼Press in Setup mode to scroll through subgroups. Also lets you increment/decrement the values in the conductivity and temperature calibration modes.

SETUP.....Press to enter SETUP mode. SETUP mode lets you customize meter preferences and defaults, and view calibration and probe data.

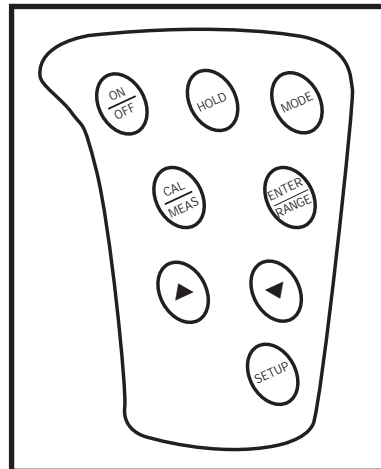

3. Preparation

3.1 Inserting the Batteries

Four AAA batteries are included with your meter.

1. Use a Phillips screwdriver to remove the two screws holding the battery cover. See figure below.
2. Lift off battery cover to expose batteries.
3. Insert batteries. Follow the diagram inside the cover for correct polarity.
4. Replace the battery cover into its original position. Screw cover back into place.

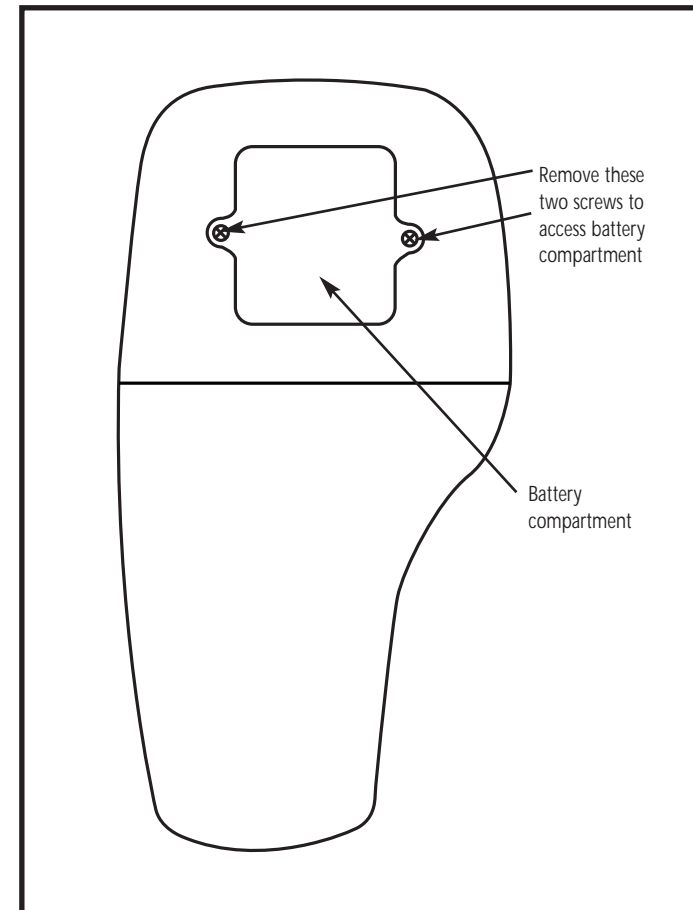

3.2 Probe information

Your meter includes two probes:

- pH electrode with BNC connector
- conductivity/TDS/temperature probe with a notched 6-pin connector

The temperature sensing element built into the conductivity probe will also compensate for pH readings as long as both probes are in your solution at the same time.

If you want to use an “All in One” pH probe with a built-in temperature element, or if you want to use a separate temperature probe, you will need to disconnect the conductivity/TDS probe to allow for connection of the separate temperature sensor.

You can use any standard pH electrode with a BNC connector with this meter. Conductivity/TDS probes, “All in One” pH electrodes with a built-in temperature element, and temperature probes require a probe with a notched 6-pin connector. For replacement probes, see the “Accessories” section, pages 46-47.

NOTE: Keep connector dry and clean. Do not touch connector with soiled hands.

To connect the pH electrode:

1. Slide the BNC connector of the probe over the BNC connector socket on the meter. Make sure the slots of the connector are in line with the posts of the socket. Rotate and push the connector clockwise until it locks.

See figure below.

2. To remove probe, push and rotate the connector counterclockwise. While holding onto the metal part of the connector, pull probe away from the meter.

CAUTION: Do not pull on the probe cord or the probe wires might disconnect.

To connect the conductivity/TDS/temperature probe:

1. Line up the notch and 6 pins on the meter with the holes in the 6-pin connector. Push down and turn the locking ring clockwise to lock into place.

See figure below.

2. To remove probe, turn the locking ring counterclockwise on the probe connector. Pull probe away from the meter.

NOTE: follow the same directions to connect an optional separate temperature element.

CAUTION: Do not pull on the probe cord or the probe wires might disconnect.

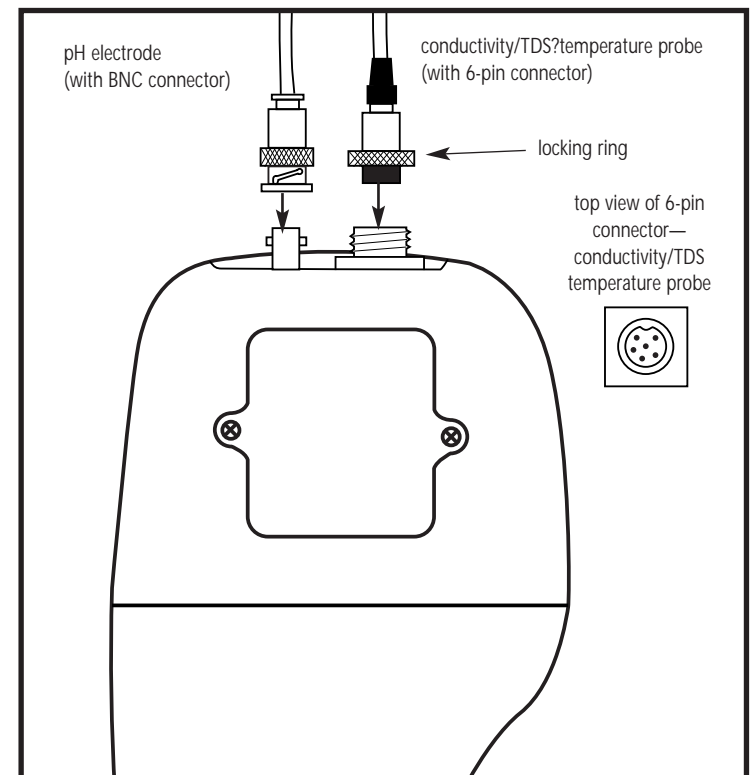

4. Calibration

4.1 Important Information on Meter Calibration

When you recalibrate your meter, old calibration points are replaced on a “point by point” basis in pH, and on a “range by range” basis in conductivity or TDS. For example:

- **pH:** if you previously calibrated your meter at pH 4.01, 7.00, and 10.01, and you recalibrate at pH 7.00, the meter retains the old calibration data at pH 4.01 and pH 10.01.
- **Conductivity/TDS:** if you previously calibrated your conductivity meter at 1413 μS in the 0 to 1999 μS range and you recalibrate at 1500 μS (also in the 0 to 1999 μS range), the meter will replace the old calibration data (1413 μS) in that range. The meter will retain all calibration data in other ranges.

TDS values are proportional to conductivity values. Note that if you calibrate a TDS value in an equivalent conductivity range, the TDS value will replace the previous conductivity value, and vice versa.

To view current calibration points:

- pH: Program P1.0 in the SETUP section, page 26.
- Conductivity/TDS: Program P5.0 in the SETUP section, page 32.

To completely recalibrate your meter, or when you use a replacement probe, it is best to clear old calibration data by resetting the meter.

To reset the meter to its factory defaults:

- pH: Program P4.0 in the SETUP section, page 31.
- Conductivity/TDS: Program P9.0 in the SETUP section, page 40.

NOTE: Resetting the meter will set meter to factory defaults. Conductivity/TDS and pH must be reset separately.

For directions on how to calibrate your meter:

- See section 4.3 on pages 11-12 for pH calibration
- See section 4.4 on page 13-15 for conductivity and TDS calibration
- See section 4.5 on page 16 for Temperature Calibration

4.2 Preparing the Meter for Calibration

Before starting calibration, make sure you are in the correct measurement mode. When you switch on the meter, the meter starts up in the units last used. For example, if you shut the meter off in "pH" units, the meter will read "pH" units when you switch the meter on.

Do not reuse calibration solutions after calibration. Contaminants in the solution can affect the calibration, and eventually the accuracy of the measurements. See pages 46-47 for information on our high-quality calibration solutions.

4.3 pH calibration

We recommend that you perform at least a 2-point calibration using standard buffers that bracket (one above and one below) the expected sample range.

Preparing for pH calibration

This meter is capable of up to 5-point pH calibration to ensure accuracy across the entire pH range of the meter. Select from the following buffer options:

pH 1.68, 4.01, 7.00, 10.01, and 12.45.

The meter automatically recognizes and calibrates to these standard buffer values, which makes pH calibration faster and easier.

Be sure to remove the protective electrode storage bottle or rubber cap of the probe before calibration or measurement. If the electrode has been stored dry, wet the probe in tap water for 10 minutes before calibrating or taking readings to saturate the pH electrode surface and minimize drift.

Wash your probe in deionized water after use, and store in electrode storage solution. If storage solution is not available, use pH 4.0 or 7.0 buffer.

To calibrate pH:

1. If necessary, press the MODE key to select pH measurement mode. The pH indicator appears in the upper right hand corner of the display.

See figure **A**

2. Rinse the pH electrode thoroughly with de-ionized water or a rinse solution. Do not wipe the probe; this causes a build-up of electrostatic charge on the glass surface.
3. Dip the pH electrode into the calibration buffer. The end of the probe must be completely immersed into the sample. Stir the probe gently to create a homogeneous sample.

NOTE: The temperature element is in the conductivity cell. For temperature compensated readings, dip the conductivity cell into the calibration buffer as well.

CONTINUED ON NEXT PAGE

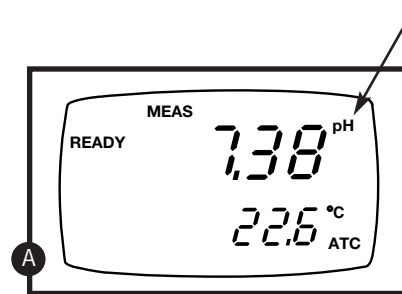

4. Press CAL/MEAS to enter pH calibration mode. The CAL indicator lights. The primary display will show the measured reading while the smaller secondary display will indicate the pH standard buffer solution.

See figure **B**

5. Wait for the measured pH value to stabilize. If the READY indicator has been activated (set up program P3.1—see page 28), the READY annunciator lights when the reading is stable.

6. Press ENTER to confirm calibration. The meter is now calibrated to the current buffer. The lower display scrolls through the remaining buffer options.

- If you are performing multipoint calibration, go to step 7.
- If you are performing one-point calibration, go to step 9.

7. Rinse the electrode with de-ionized water or a rinse solution, and place it in the next pH buffer.

8. Follow steps 5 to 8 for additional calibration points.

9. When calibration is complete, press CAL/MEAS to return to pH measurement mode.

See figure **C**

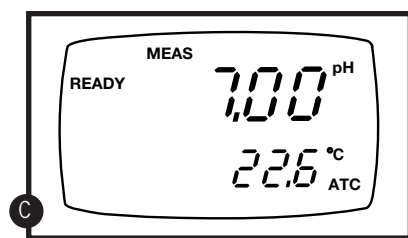
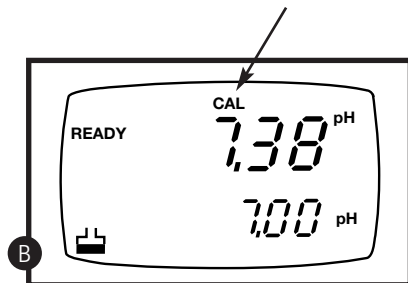

Notes

To exit from pH Calibration mode without confirming calibration, DO NOT press ENTER in step 6. Press CAL/MEAS instead.

If the selected buffer value is not within ± 1.0 pH from the measured pH value: the electrode and buffer icon blink and the ERR annunciator appears in the lower left corner of the display.

To limit the number of pH buffer values available during calibration, see Set-up program P3.2 on page 29.

4.3 Conductivity and TDS calibration

Calibrate up to 5-point conductivity or 5 point TDS calibration at one point per range:

Range	Conductivity:	TDS:
R1	0.00-19.99 μS	0.00-9.99 ppm
R2	0.0-199.9 μS	10.0-99.9 ppm
R3	0-1999 μS	100-999 ppm
R4	0.00-19.99 mS	1.00-9.99 ppt
R5	0.0-199.9 mS	10.0-199.9 ppt

If you are measuring values in more than one range, make sure to calibrate each of the ranges you are measuring. All new calibration data will over-ride existing stored calibration data for each measuring range you calibrate.

- If you are measuring in ranges near to or greater than 20 mS (10 ppt), or near to or lower than 100 μS (50 ppm), calibrate the meter at least once a week to get specified $\pm 1\%$ F.S. accuracy.
- If you are measuring in the mid ranges and you washed the probe in deionized water and stored it dry, calibrate the meter at least once a month.
- If you take measurements at extreme temperatures, calibrate the meter at least once a week.

Preparing for conductivity/TDS calibration

For best results, select a standard value close to the sample value you are measuring. Alternatively, use a calibration solution value that is approximately $\frac{1}{2}$ the full scale value of the measurement range you plan to use. For example, in the 0 to 1999 μS conductivity range, use a 1413 μS solution for calibration.

See the table below for recommended calibration solution ranges:

Conductivity Range	Recommended Cal. Solution Range	TDS Range	Recommended Cal. Solution Range
0.00-19.99 μS	6.00 to 17.00 μS	0.00-9.99 ppm	3.00 to 8.50 ppm
0.0-199.9 μS	60.0 to 170.0 μS	10.0-99.9 ppm	30.0 to 85.0 ppm
0-1999 μS	600 to 1700 μS	100-999 ppm	300 to 850 ppm
0.00-19.99 mS	6.00 to 17.00 mS	1.00-9.99 ppt	3.00 to 8.50 ppt
0.0-199.9 mS	60.0 to 170.0 mS	10.0-199.9 ppt	30.0 to 170 ppt

Temperature coefficient: These meters are factory set to a temperature coefficient of 2.1% per $^{\circ}\text{C}$. For most applications this will provide good results. See Program P8.1 on page 38 to set the temperature coefficient to a different value. See Appendix 31, “Calculating Temperature Coefficients” on page 50 to determine the appropriate temperature coefficient for your solution.

Normalization temperature: The factory default value for normalization temperature is 25 $^{\circ}\text{C}$. If you need to normalize to a value other than 25 $^{\circ}\text{C}$, see Program P8.2 on page 39.

CONTINUED ON NEXT PAGE

To calibrate conductivity:

1. If necessary, press the MODE key to select conductivity mode.

See figure **A**

2. Rinse the probe thoroughly with de-ionized water or a rinse solution, then rinse with a small amount of calibration standard.
3. Dip the probe into the calibration standard. Immerse the probe tip beyond the upper steel band. Stir the probe gently to create a homogeneous sample.

See figure **B**

4. Wait for the measured conductivity value to stabilize. If the READY indicator has been activated (set up program P7.1—see page 34), the READY annunciator lights when the reading is stable.

5. Press CAL/MEAS to enter conductivity calibration mode. The CAL indicator will appear above the display.

See figure **C**

6. Press the ▲ or ▼ to change the value on the primary display to match the value of the calibration standard.

See figure **D**

7. Press ENTER to confirm the calibration value. The meter returns to the MEAS (measurement) mode.

8. Repeat steps 1-7 for other ranges.

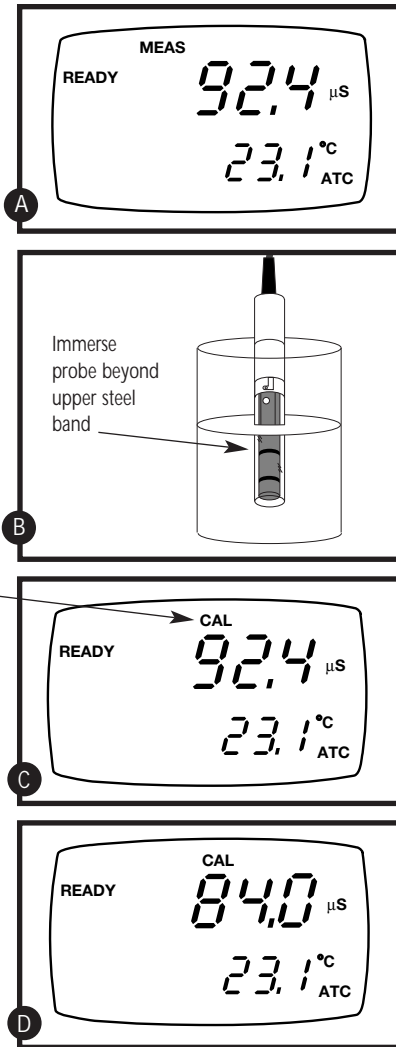

Notes

When entering calibration mode, the meter will display the factory default value. If the meter was previously calibrated, the display may “jump” to the factory default value when switching from measurement to calibration mode.

To exit from Conductivity Calibration mode without confirming calibration, DO NOT press ENTER in step 6. Press CAL/MEAS instead. This will retain the meter’s old calibration data in the measuring range of the calibration.

You can offset the conductivity reading up to ±20% from the default setting. If your measured value differs by more than ±20%, clean or replace probe as needed. See page 47 for a wide selection of high-quality calibration standards.

Calibrating for TDS directly

The factory default setting for TDS conversion factor is 0.5. If your solution has a different TDS factor, you can improve calibration accuracy by setting the TDS factor prior to calibration. See SetUp Program P7.4 on page 37 for directions. See Appendixes 1 and 2 on pages 48-49 to determine your exact TDS factor.

1. If necessary, press the MODE key to select TDS mode.

See figure **A**

2. Rinse the probe with de-ionized water or a rinse solution, then rinse with a small amount of calibration standard.
3. Dip the probe into the calibration standard. Immerse the probe tip beyond the upper steel band. Stir the probe gently to create a homogeneous sample.

See figure **B**

4. Wait for the measured TDS value to stabilize. If the READY indicator has been activated (set up program P7.1—see page 34), the READY annunciator lights when the reading is stable.

5. Press CAL/MEAS to enter TDS calibration mode. The CAL indicator will appear above the display.

See figure **C**

6. Press the ▲ or ▼ keys to change the value on the primary display to match the value of the calibration standard.

See figure **D**

7. Press ENTER to confirm the calibration value. The meter returns to the MEAS (measurement) mode.

8. Repeat steps 1-7 for other ranges.

Notes

When entering calibration mode, the meter will display the factory default value. If the meter was previously calibrated, the display may “jump” to the factory default value when switching from measurement to calibration mode.

To exit from TDS Calibration mode without confirming calibration, DO NOT press ENTER in step 6. Press CAL/MEAS instead. This will retain the meter’s old calibration data in the measuring range of the calibration.

You can offset the TDS reading up to ±20% from the default setting. If your measured value differs by more than ±20%, clean or replace probe as needed.

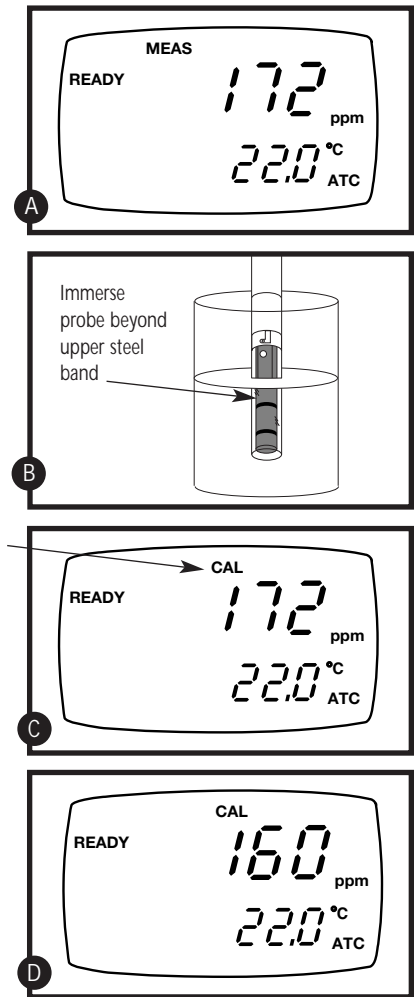

4.5 Temperature calibration

The temperature sensor (located in the conductivity cell) is factory calibrated. Calibrate your sensor only if you suspect sensor drift that may have occurred over a long period of time or if you have a replacement probe.

Temperature calibration

1. Make sure the conductivity cell (or alternative temperature element) is attached to the 6-pin connector.
2. Switch the meter on. The ATC annunciator will appear at the right-hand side of the LCD.
3. Press the CAL/MEAS key to enter calibration mode (either pH or conductivity). The CAL indicator will appear above the primary display.
4. While in calibration mode, press the MODE key to enter temperature calibration mode. The primary display shows the last set temperature value and the secondary display shows the temperature reading with zero offset.

See figure **A**

5. Dip the ATC element into a solution of known temperature (i.e. a temperature bath). Allow time for the temperature element to stabilize.
6. Scroll with the ▼ and ▲ keys to set the correct temperature value (i.e. the temperature of the temperature bath). You can adjust the reading in increments of 0.1°C.

See figure **B**

7. Once you have selected the correct temperature, press the ENTER key. The meter automatically returns to pH measurement mode.

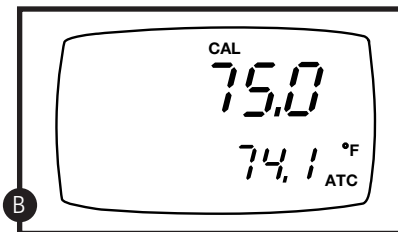
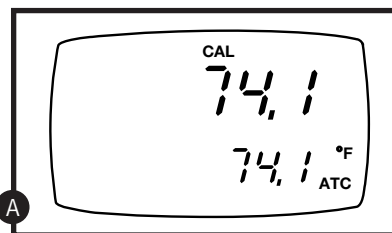

Notes

- You can offset the temperature reading up to $\pm 5^{\circ}\text{C}$ from the original reading.
- To exit this program without confirming the temperature calibration value, DO NOT press ENTER in step 7. Press CAL/MEAS instead.

5. Measurement

5.1 Taking pH Measurements

To take readings:

1. Rinse the pH electrode with deionized or distilled water before use to remove any impurities adhering to the probe body. If the pH electrode has dehydrated, soak it for 30 minutes in electrode storage solution or a 2M–4M KCl solution.
2. Press ON to switch on meter.
3. Press the MODE key to select pH measurement mode. The MEAS annunciator appears on the top center of the LCD. The ATC indicator appears in the lower right hand corner to indicate Automatic Temperature Compensation.

See figure **A**

NOTE: For pH manual temperature compensation, you must disconnect the conductivity cell from the 6-pin connector. The ATC indicator will disappear from the display. You also need to set a manual temperature compensation value—see page 22 for directions.

4. Dip the pH electrode into the sample. Since the conductivity cell contains the temperature sensor, make sure it is also immersed in your solution.

When dipping the probe into the sample, the sensor or the glass bulb of the electrode must be completely immersed into the sample. Stir the probe gently in the sample to create a homogenous sample.

5. Allow time for the reading to stabilize. Note the reading on the display. If the Ready indicator is selected on, it will appear when the reading is stable. See page 20 for more information.
6. Press the MODE key to toggle between pH and conductivity readings.

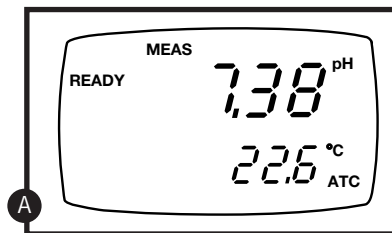

5.2 Taking Conductivity or TDS Measurements

To take readings:

1. Rinse the probe with deionized or distilled water before use to remove any impurities adhering to the probe body. Shake or air dry. To avoid contamination or dilution of your sample, rinse probe with a small volume of your sample liquid.
2. Press ON to switch on meter.
3. Press the MODE key to select conductivity (or TDS) measurement mode. The MEAS annunciator appears on the top center of the LCD. The ATC indicator appears in the lower right hand corner to indicate Automatic Temperature Compensation.

See figure **A**

NOTE: For conductivity manual temperature compensation, you must deactivate the temperature sensor built into the conductivity probe and set a manual temperature compensation value. See pages 21-22 for directions. The ATC indicator will disappear from the display.

4. Dip the probe into the sample.

When dipping the probe into the sample, the tip of the probe must be immersed above the second steel band. Stir the probe gently in the sample to create a homogenous sample.

See figure **B**

5. Allow time for the reading to stabilize. Note the reading on the display. If the Ready indicator is selected on, it will appear when the reading is stable. See page 20 for more information.
6. Press the MODE key to toggle between conductivity and pH readings.

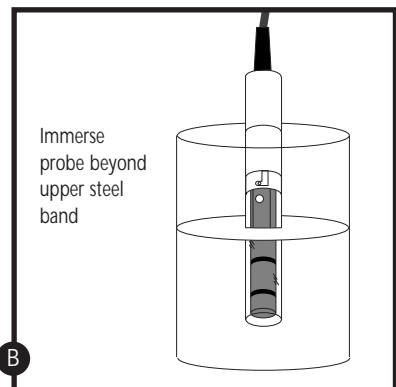
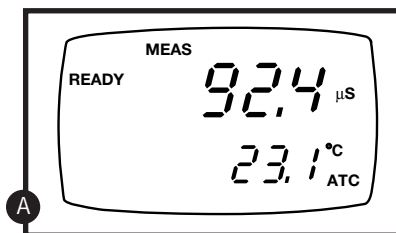

5.3 HOLD function

This feature lets you freeze your reading for a delayed observation. HOLD can be used any time when in MEAS mode.

1. To hold a measurement, press the HOLD key while in measurement mode. "HOLD" will appear on the display.

See figure **C**

2. To release the held value, press HOLD again. Continue to take measurements.

NOTE: This meter shuts off automatically after 20 minutes of nonuse. If the meter is shut off either automatically or manually, the HOLD value will be lost.

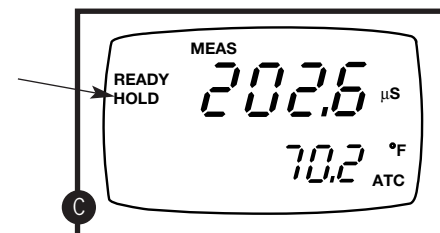

Taking measurements with READY indicator selected on

If the READY indicator has been activated, the READY annunciator lights when the reading is stable. Switch the READY indicator on or off in Set up program P7.1—see page 34 for directions.

Taking measurements with the auto endpoint feature selected on

When a reading is stable for more than 5 seconds, the auto endpoint feature will automatically "hold" the reading. The "hold" indicator appears on the left side of the display. Press the HOLD key to release the reading. Switch the Auto endpoint feature on or off in Set up program P7.1—see page 34 for directions.

Notes

You can use the conductivity/TDS manual ranging function to select a specific range in which your readings will appear. See page 20 for directions.

5.4 Using manual ranging function: conductivity/TDS

When shipped from the factory, your meter automatically selects the range in which your readings appear. The manual ranging function lets you select the specific range in which you want to work.

From measurement mode:

- To select the desired measuring range, press the RANGE key while in Conductivity measurement mode. The first range will appear on the display. The “MEAS” indicator blinks, and the “Range” number flashes briefly in the lower display.

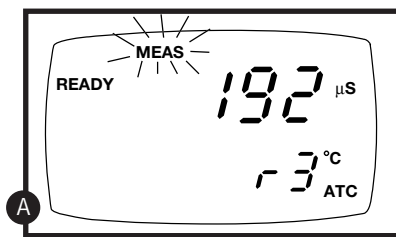

Range	Conductivity:	TDS:
R1	0.00-19.99 µS	0.00-9.99 ppm
R2	0.0-199.9 µS	10.0-99.9 ppm
R3	0-1999 µS	100-999 ppm
R4	0.00-19.99 mS	1.00-9.99 ppt
R5	0.0-199.9 mS	10.0-199.9 ppt

See figure **A**

- Press the RANGE key again (if needed) until desired range is selected.
- To reselect the Auto-ranging function, repeatedly press the RANGE key until the “MEAS” indicator appears without blinking.

Notes

This meter will not let you manually select a range in which the reading will be overrange.

The meter resets to the Auto-ranging function once it is turned off. You will have reset the manual ranging function each time you turn the meter off.

5.5 Selecting manual temperature compensation: conductivity or TDS

For manual temperature compensation in conductivity or TDS mode, you must:

- Deactivate the temperature element built into the conductivity/TDS probe.
- Select a manual temperature compensation value (see page 22).

You can deactivate the temperature element (select manual temperature compensation) in Set Up Program P7.3.

From measurement mode

- Press the Mode key to select conductivity measurement mode.
- Press Setup key to enter Set Up mode.
- Press the ▲ and ▼ keys to scroll through subgroups until you view parameter P7.0.

See figure **A**

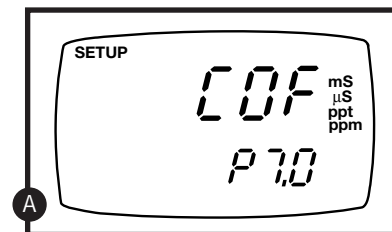

- Press the ENTER key three times to select parameter 7.3. The upper display shows “ATC” and the lower display shows “P7.3”.

See figure **B**

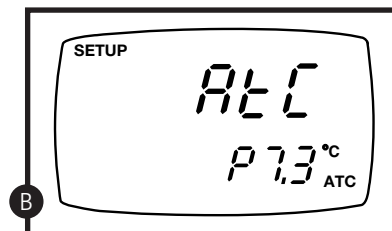

- Press the ENTER key again. The upper display shows “ATC” and the lower display shows “YES” or “NO”.

- Press the ▲ and ▼ keys to select the Automatic Temperature Compensation off.
 - YES = ATC on
 - NO = ATC off (manual compensation)

See figure **C**

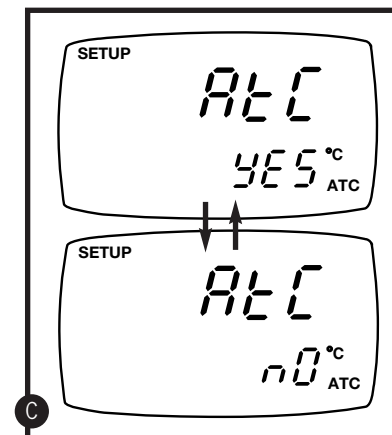

- Press the ENTER key to confirm selection and to return to the subgroup menu. Press the CAL/MEAS key to return to measurement mode.

Note that the ATC indicator no longer appears on the display.

Go to page 22 to select a manual temperature compensation value.

5.6 Selecting the manual temperature compensation value

To use manual temperature compensation, you need to enter the temperature value of your process into the meter. This is the value at which readings will manually temperature compensate. You can select any temperature between 0 and 100°C (32 and 212°F). Default value is 25°C (77°F).

To select a manual temperature compensation value:

1. Press the MODE key to select the measurement mode in which you need to use manual temperature compensation.
2. If necessary, select ATC off.
pH: see NOTE on page 17
Conductivity/TDS: see page 21
 When ATC is off, the ATC indicator disappears from the lower right corner of the display.

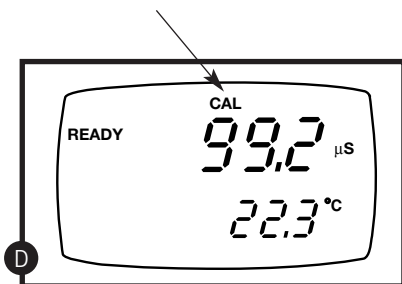

3. Press the CAL/MEAS key to enter calibration mode. The CAL indicator will appear above the primary display.

See figure **D**

4. While in calibration mode, press the MODE key to enter temperature calibration mode. The primary display shows the current temperature setting and the secondary display shows the last set temperature value.

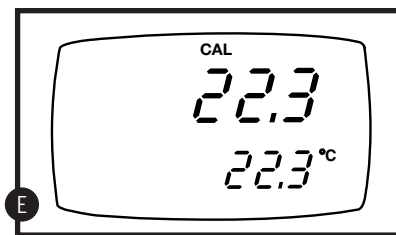

See figure **E**

5. Check the temperature of your sample using an accurate thermometer.
6. Press the ▲ or ▼ keys to offset the temperature to the measured value from step 5.

See figure **F**

7. Press ENTER to confirm the selected temperature and to return to measurement mode.

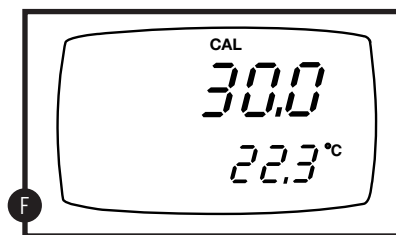

The meter will now compensate readings for the manually set temperature.

Notes

To exit this program without confirming the manual temperature compensation value, DO NOT press ENTER in step 7. Press CAL/MEAS instead.

Setting the manual temperature compensation value for conductivity or TDS will change the manual temperature compensation value for pH to the same value, and vice versa.

6. Advanced set up functions

The advanced set up mode lets you customize your meter's preferences and defaults. Your OAKTON waterproof meter features different sub groups that organize all set-up parameters.

This meter blanks out sub groups that do not apply to the measurement mode [conductivity/TDS or pH] you are in when you enter Setup mode.

The full selection of available sub groups are:

pH sub groups

1. P1.0: Viewing pH calibration data
2. P2.0: Viewing pH probe data
3. P3.0: pH configuration
4. P4.0: Resetting meter to factory default (pH settings)

Conductivity/TDS sub groups

5. P5.0: Viewing conductivity (TDS) calibration data
6. P6.0: Viewing conductivity (TDS) probe data
7. P7.0: Conductivity (TDS) configuration
8. P8.0: Conductivity (TDS) temperature parameters
9. P9.0: Resetting meter to factory default (conductivity/TDS settings)

See pages 24-25 for a more detailed overview on the different parameters available in the sub group modes.

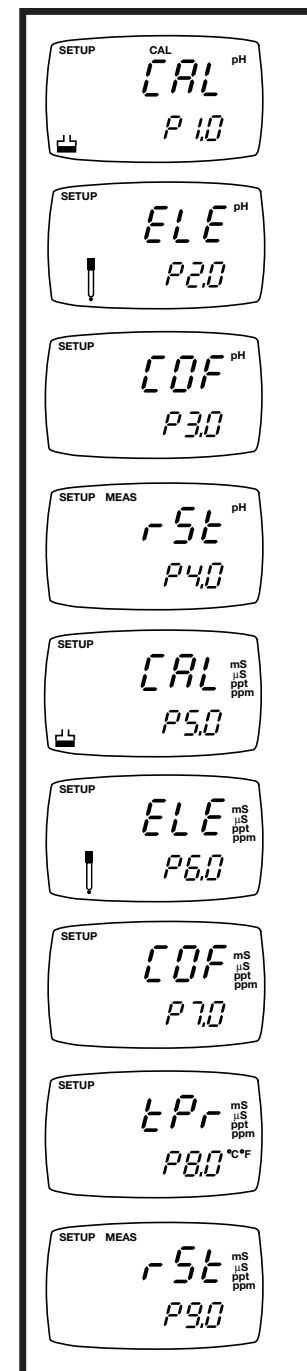

6.1 Advanced set-up mode detailed overview

Press the SETUP key to enter Set up mode. Press the ▲ and ▼ keys to scroll through sub groups.

Sub groups available from pH measurement mode

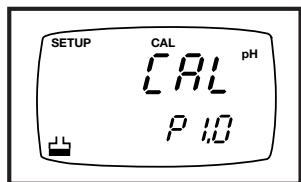

Instructions on page 26

P1.0: Viewing pH calibration data

- P1.1 View previous pH calibration data (pH 1.68)
- P1.2 View previous pH calibration data (pH 4.01)
- P1.3 View previous pH calibration data (pH 7.00)
- P1.4 View previous pH calibration data (pH 10.01)
- P1.5 View previous pH calibration data (pH 12.45)

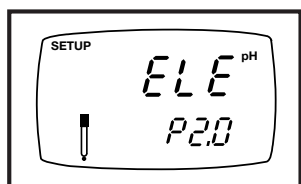

Instructions on page 27

P2.0: Viewing pH electrode data

- P2.1 View electrode offset
- P2.2 View electrode slope

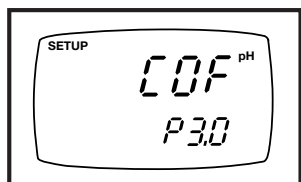

Instructions on pages 28-30

P3.0: pH configuration

- P3.1 Ready indicator on or off / auto endpoint on or off
- P3.2 Select number of pH calibration points
- P3.3 Select °F or °C

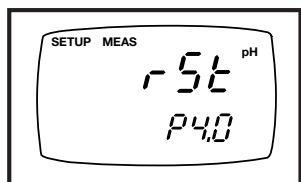

Instructions on page 31

P4.0: Reset to factory default (pH)

Reset pH data to factory default settings

Sub groups available from conductivity/TDS measurement mode

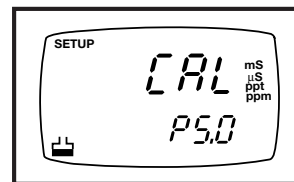

Instructions on page 32

P5.0: Viewing Con./TDS calibration data

- P5.1 View conductivity/TDS calibration data R1
R1 = 0.00-19.99 µS / 0.00-9.99 ppm
- P5.2 View conductivity/TDS calibration data R2
R2 = 0.0-199.9 µS / 10.0-99.9 ppm
- P5.3 View conductivity/TDS calibration data R3
R3 = 0-1999 µS / 100-999 ppm
- P5.4 View conductivity/TDS calibration data R4
R4 = 0.00-19.99 mS / 1.00-9.99 ppt
- P5.5 View conductivity/TDS calibration data R5
R5 = 0.0-199.9 mS / 10.0-199.9 ppt

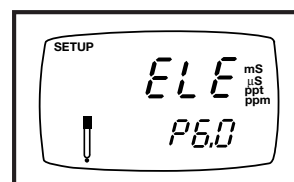

Instructions on page 33

P6.0: Viewing Con./TDS probe data

- P6.1 View effective cell constant R1
R1 = 0.00-19.99 µS / 0.00-9.99 ppm
- P6.2 View effective cell constant R2
R2 = 0.0-199.9 µS / 10.0-99.9 ppm
- P6.3 View effective cell constant R3
R3 = 0-1999 µS / 100-999 ppm
- P6.4 View effective cell constant R4
R4 = 0.00-19.99 mS / 1.00-9.99 ppt
- P6.5 View effective cell constant R5
R5 = 0.0-199.9 mS / 10.0-199.9 ppt

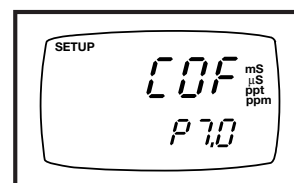

Instructions on pages 34-37

P7.0: Con./TDS configuration

- P7.1 Ready indicator on or off / auto endpoint on or off
- P7.2 Select °F or °C
- P7.3 Select ATC/Manual Temperature Compensation
- P7.4 Set TDS factor

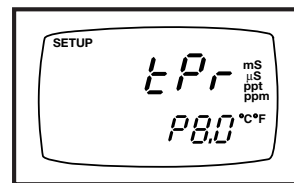

Instructions on pages 38-39

P8.0: Temperature parameters

- P8.1 Set temperature coefficient
- P8.2 Set normalization temperature

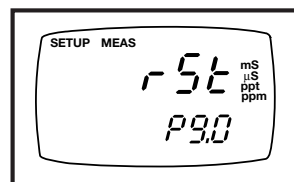

Instructions on page 40

P9.0: Reset to factory default (Con./TDS)

Reset conductivity data to factory default settings

6.2 P1.0: Viewing previous pH calibration data

This mode lets you recall previous pH calibration data, which lets you know at which points this meter was previously calibrated. This is a “view only” mode.

From measurement mode:

1. Press the Mode key to select pH measurement mode.
2. Press the Set up key to enter Set Up mode.

See figure **A**

3. Press the ▲ and ▼ keys to scroll through subgroups until you view parameter P1.0.

4. Press the ENTER key repeatedly to view previous calibration data.

P1.1 = pH 1.68
P1.2 = pH 4.01
P1.3 = pH 7.00
P1.4 = pH 10.01
P1.5 = pH 12.45

See figure **B**

5. When you have scrolled through all calibration data, you will automatically return to the subgroup menu. Press the CAL/MEAS key to return to measurement mode.

Notes

If there is no previous calibration data at a particular point, the primary display will show “---”.

See figure **C**

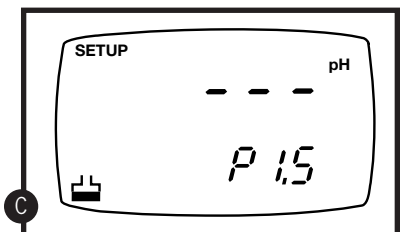
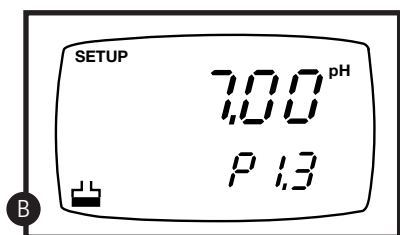
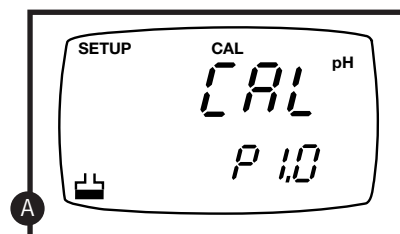

6.3 P2.0: Viewing pH electrode data

Program 2 has two “view only” options that lets you check the pH electrode parameters for diagnostic purposes. It lets you view:

P2.1: Electrode offset

P2.2 Electrode slope

From measurement mode

1. Press the Mode key to select pH measurement mode.
2. Press the Setup key to enter Set Up mode.
3. Press the ▲ and ▼ keys to scroll through subgroups until you view parameter P2.0.

See figure **A**

4. Press the ENTER key to select parameter P2.1.
5. The display shows the electrode offset value (the mV offset at pH 7.00). If you have not calibrated at any buffer, the primary display shows 0.00 mV.

See figure **B**

6. Press the ENTER key to select parameter P2.2.
7. The display shows electrode slope in percentage. Slope displayed is the average slope based on the pH calibrations. Default setting is 100.0.

See figure **C**

8. Press the ENTER key to return to the subgroup menu. Press the CAL/MEAS key to return to measurement mode.

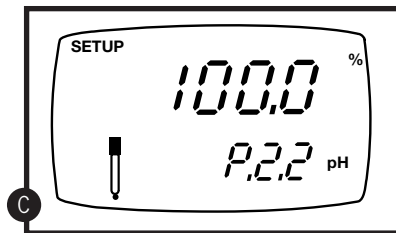
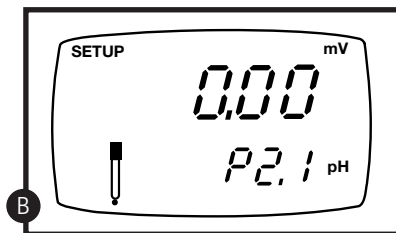
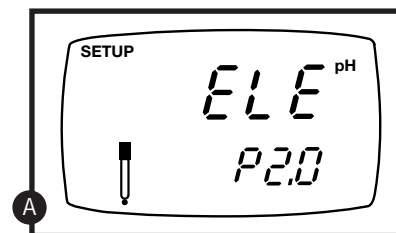

6.4 P3.0: pH measurement configuration

P3.1: READY indicator and auto endpoint function

This program lets you select:

- “**READY indicator on**” to indicate when the reading is stable.
- “**READY indicator off**” for faster meter response.
- **Auto endpoint function on**. Select auto endpoint on to “hold” the reading when it is stable for more than 5 seconds. The display automatically freezes, and the HOLD indicator appears on the left side of the display. Press the HOLD key to release the display and access other functions.

From measurement mode

1. Press the Mode key to select pH measurement mode.
2. Press Setup key to enter Set Up mode.
3. Press the ▲ and ▼ keys to scroll through subgroups until you view parameter P3.0.

See figure **A**

4. Press the ENTER key to select parameter 3.1.

See figure **B**

5. Press the ▲ and ▼ keys to select the configuration you require.
 - OFF switches the READY indicator off.
 - ON switches the READY indicator on.
 - ON and HOLD together switches the auto endpoint feature on.
6. Press the ENTER key to confirm selection and to proceed to step 4 of P3.2. Press the CAL/MEAS key twice to return to measurement mode.

Notes

Meter default is set for Ready indicator on, and auto endpoint function off.

You can also change the Ready indicator and auto endpoint function in Program P7.1 (available from conductivity/TDS mode). Any changes you make to the Ready indicator/ auto endpoint function in pH mode will also change in conductivity mode.

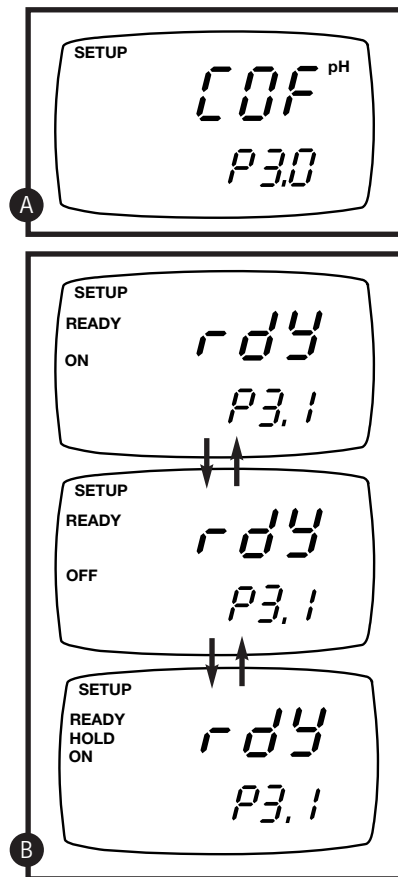

P3.2: Selecting number of pH calibration points

Program P3.2 lets you select the number of pH calibration points the meter will use in calibration mode: 2, 3, 4, or 5. The meter will automatically exit calibration mode after you have calibrated to your selected number of points.

From measurement mode

1. Press the Mode key to select pH measurement mode.
2. Press Setup key to enter Set Up mode.
3. Press the ▲ and ▼ keys to scroll through subgroups until you view parameter P3.0.

See figure **C**

4. Press the ENTER key twice to select parameter 3.2.

See figure **D**

5. Press the ▲ and ▼ keys to select 2, 3, 4, or 5 point pH calibration.
6. Press the ENTER key to confirm selection and to proceed to step 5 of P3.3. Press the CAL/MEAS key twice to return to measurement mode.

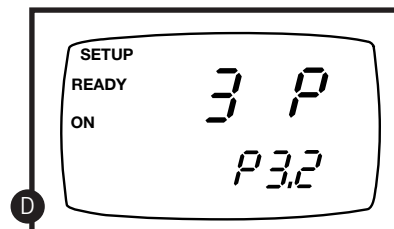
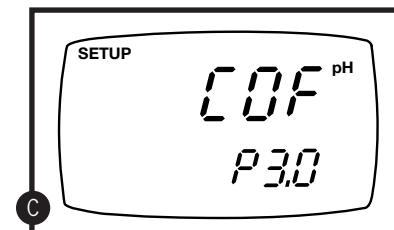

P3.3 Selecting °C or °F

This meter lets you select between °C and °F units for temperature readings.

From measurement mode

1. Press the Mode key to select pH measurement mode.
2. Press Setup key to enter Set Up mode.
3. Press the ▲ and ▼ keys to scroll through subgroups until you view parameter P3.0.

See figure **E**

4. Press the ENTER key four times to select parameter 3.3.

See figure **F**

5. Press the ▲ and ▼ keys to toggle between °C and °F.
6. Press the ENTER key to confirm selection and to return to the subgroup menu. Press the CAL/MEAS key to return to measurement mode.

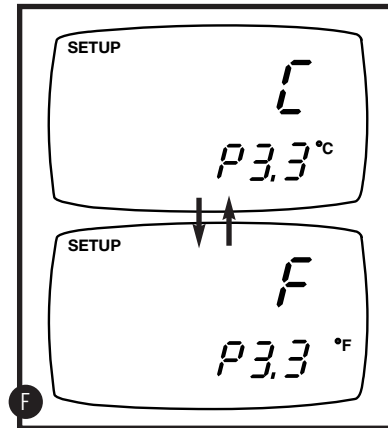
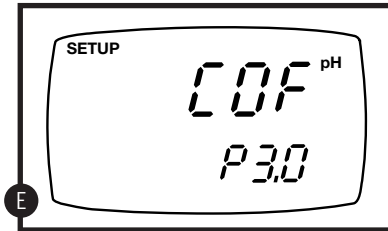

Notes

You can also switch between °C and °F in Program P7.2 (available from conductivity/TDS mode). If you switch between °C and °F in pH mode, the meter will also switch in conductivity mode.

6.5 P4.0: Resetting to factory default settings (pH)

This program lets you reset all pH parameters to factory default settings. This clears all calibration data any other pH setup functions you might have changed. The following settings will remain as you have set them:

- temperature unit of measure (°C or °F)
- The temperature offset calibration value
- All conductivity/TDS calibration data and parameters

From measurement mode

1. Press the Mode key to select pH measurement mode.
2. Press Setup key to enter Set Up mode.
3. Press the ▲ and ▼ keys to scroll through subgroups until you view parameter "P4.0" in the lower display.

See figure **A**

4. Press the ENTER key.

See figure **B**

5. Press the ▲ and ▼ keys to toggle between NO and YES.
 - NO retains current settings
 - YES resets to factory default settings
6. Press the ENTER key to confirm selection and to return to measurement mode.

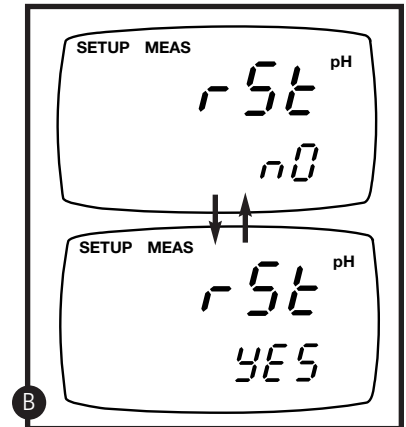
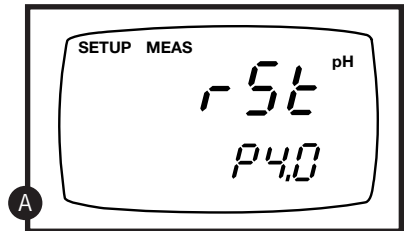

Notes

To reset all conductivity and TDS data, see page 40.

See page 51 for a table of factory default settings.

6.6 P5.0: Viewing previous conductivity/TDS calibration data

This mode lets you recall previous conductivity or TDS calibration data, which lets you know at which points this meter was previously calibrated. This is a "view only" mode.

TDS values are proportional to conductivity values. Note that if you calibrate a TDS value in an equivalent conductivity range, the TDS value will replace the previous conductivity value, and vice versa.

From measurement mode:

1. Press the Mode key to select conductivity or TDS measurement mode.
2. Press the Set up key to enter Set Up mode.

See figure **A**

3. Press the ▲ and ▼ keys to scroll through subgroups until you view parameter P5.0.

4. Press the ENTER key repeatedly to view previous calibration data.

Range	Conductivity:	TDS:
P5.1 (R1)	0.00-19.99 μ S	0.00-9.99 ppm
P5.2 (R2)	0.0-199.9 μ S	10.0-99.9 ppm
P5.3 (R3)	0-1999 μ S	100-999 ppm
P5.4 (R4)	0.00-19.99 mS	1.00-9.99 ppt
P5.5 (R5)	0.0-199.9 mS	10.0-199.9 ppt

See figure **B**

5. When you have scrolled through all calibration data, you will automatically return to the subgroup menu. Press the CAL/MEAS key to return to measurement mode.

Notes

If there is no previous calibration data at a particular point, the primary display will show "---".

See figure **C**

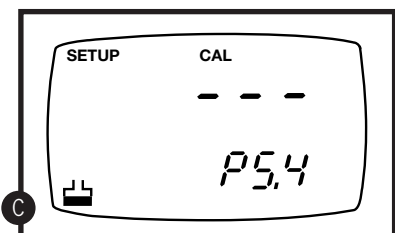
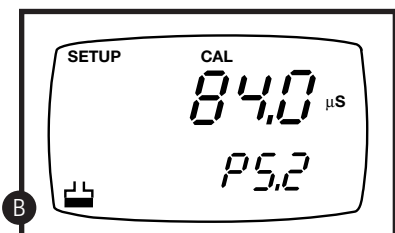
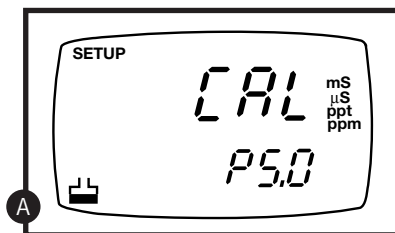

6.7 P6.0: Viewing conductivity/TDS probe data

Program 3 has five "view only" options that let you check your conductivity/TDS probe's parameters for diagnostic purposes. These options show you the effective cell constant for each range. The cell constant is adjusted according to your calibration.

From measurement mode:

1. Press the Mode key to select conductivity or TDS measurement mode.
1. Press the Set up key to enter Set Up mode.
2. Press the ▲ and ▼ keys to scroll through subgroups until you view parameter P6.0.

See figure **A**

3. Press the ENTER key repeatedly to view the effective cell constant for each range.

Range	Conductivity:	TDS:
P6.1 (R1)	0.00-19.99 μ S	0.00-9.99 ppm
P6.2 (R2)	0.0-199.9 μ S	10.0-99.9 ppm
P6.3 (R3)	0-1999 μ S	100-999 ppm
P6.4 (R4)	0.00-19.99 mS	1.00-9.99 ppt
P6.5 (R5)	0.0-199.9 mS	10.0-199.9 ppt

See figure **B**

4. When you have scrolled through all probe data, you will automatically return to the subgroup menu. Press the CAL/MEAS key to return to measurement mode.

Notes

Cell constants will degrade with time and usage. You can use this feature to alert you to when your probe needs cleaning or to when you need to replace your probe.

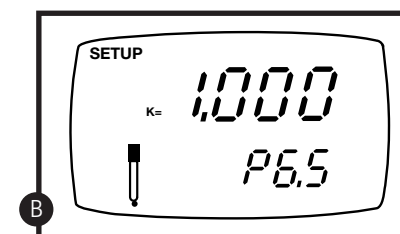
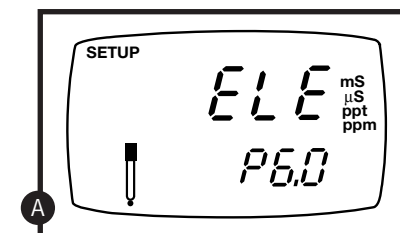

6.8 P7.0: Conductivity/TDS measurement configuration

P7.1: READY indicator and auto endpoint function

This program lets you select:

- “READY indicator on” to indicate when the reading is stable.
- “READY indicator off” for faster meter response.
- Auto endpoint function on. Select auto endpoint on to “hold” the reading when it is stable for more than 5 seconds. The display automatically freezes, and the HOLD indicator appears on the left side of the display. Press the HOLD key to release the display and access other functions.

From measurement mode

1. Press the Mode key to select conductivity or TDS measurement mode.
2. Press Setup key to enter Set Up mode.
3. Press the ▲ and ▼ keys to scroll through subgroups until you view parameter P7.0.

See figure **A**

4. Press the ENTER key to select parameter 7.1.

See figure **B**

5. Press the ▲ and ▼ keys to select the configuration you require.
 - ON switches the READY indicator on.
 - OFF switches the READY indicator off.
 - ON and HOLD together switches the auto endpoint feature on.
6. Press the ENTER key to confirm selection and to proceed to step 4 of P.7.2. Press the CAL/MEAS key twice to return to measurement mode.

Notes

Meter default is set for Ready indicator on, and auto endpoint function off.

You can also change the Ready indicator and auto endpoint function in Program P3.1 (available from pH mode). Any changes you make to the Ready indicator/ auto endpoint function in conductivity mode will also change in pH mode.

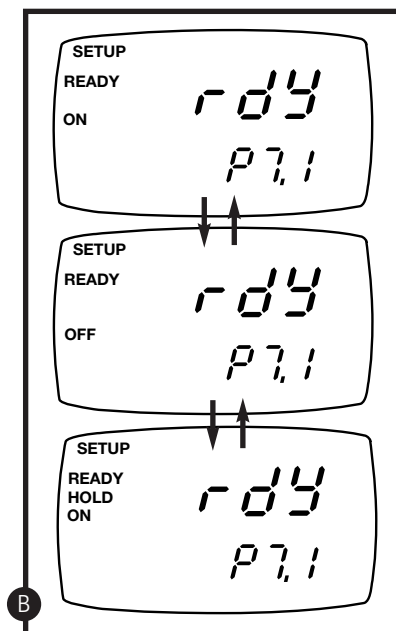

P7.2 Selecting °C or °F

This meter lets you select between °C and °F units for temperature readings.

From measurement mode

1. Press the Mode key to select conductivity or TDS measurement mode.
2. Press Setup key to enter Set Up mode.
3. Press the ▲ and ▼ keys to scroll through subgroups until you view parameter P7.0.

See figure **C**

4. Press the ENTER key four times to select parameter 7.2.

See figure **D**

5. Press the ▲ and ▼ keys to toggle between °C and °F.
6. Press the ENTER key to confirm selection and to proceed to step 4 of P7.3. Press the CAL/MEAS key twice to return to measurement mode.

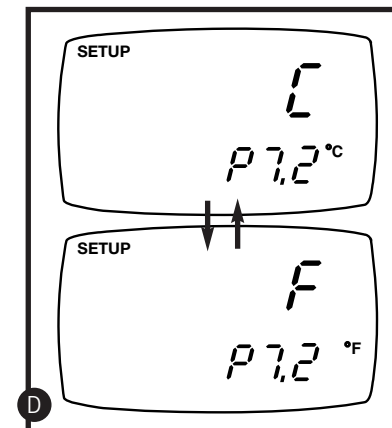
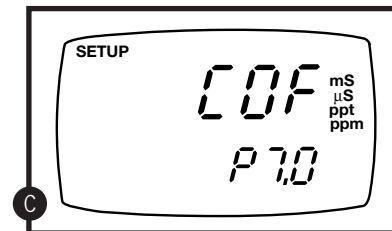

Notes

You can also switch between °C and °F in Program P3.3 (available from pH mode). If you switch between °C and °F in conductivity mode, the meter will also switch in pH mode.

P7.3 Selecting Automatic or Manual Temperature Compensation

This feature lets you select between Automatic Temperature Compensation (ATC) and Manual Temperature Compensation for conductivity (it lets you deactivate the temperature sensor in the conductivity/TDS probe). Meter default is ATC.

From measurement mode

1. Press the Mode key to select conductivity or TDS measurement mode.
2. Press Setup key to enter Set Up mode.
3. Press the ▲ and ▼ keys to scroll through subgroups until you view parameter P7.0.

See figure E

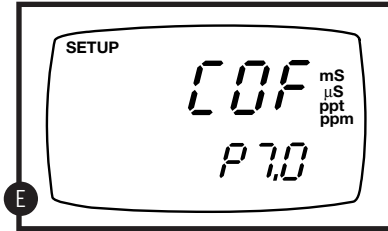

4. Press the ENTER key three times to select parameter 7.3. The upper display shows “ATC” and the lower display shows “P7.3”.

See figure F

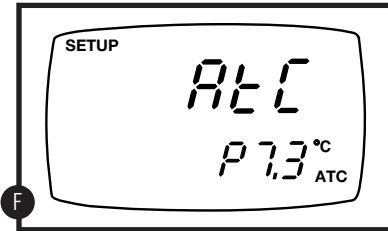

5. Press the ENTER key again. The upper display shows “ATC” and the lower display shows “YES” or “NO”.

See figure G

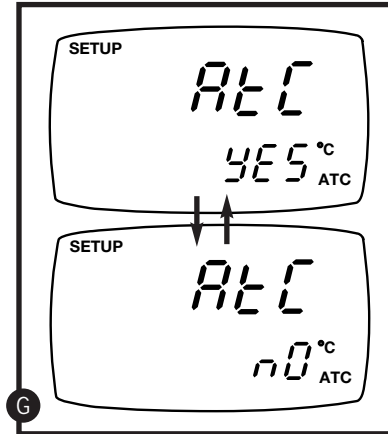

6. Press the ▲ and ▼ keys to select the Automatic Temperature Compensation on or off.
 - YES = ATC on
 - NO = ATC off (manual compensation)
7. Press the ENTER key to confirm selection and to proceed to step 4 of P7.4. menu. Press the CAL/MEAS key twice to return to measurement mode.

P7.4 Setting the TDS factor

The concentration of salts dissolved in solution increases the conductivity of that solution. This relationship varies from salt to salt and is roughly linear over a given range for a given salt. The TDS conversion factor is the number used by the meter to convert from conductivity to TDS.

To determine the conductivity to TDS conversion factor for your solution:

- Appendix 1 on page 48 lists some commonly used conversion factors.
- Appendix 2 on page 49 describes how to calculate the TDS conversion factor for other solutions.

You can set the TDS conversion factor between 0.4 and 1.0; meter default is 0.5.

From measurement mode

1. Press the Mode key to select conductivity or TDS measurement mode.
2. Press Setup key to enter Set Up mode.
3. Press the ▲ and ▼ keys to scroll through subgroups until you view parameter P7.0.

See figure H

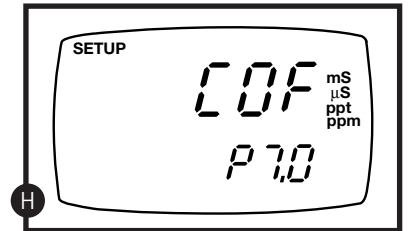

4. Press the ENTER key five times to select parameter 7.4. The upper display shows “tdS” and the lower display shows “P7.4”.

See figure I

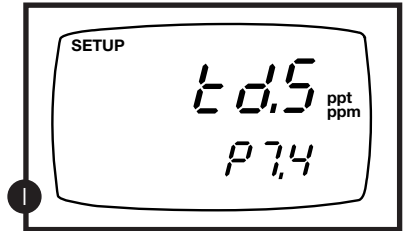

5. Press the ENTER key again. The upper display shows a value and the lower display shows “tdS”.

See figure J

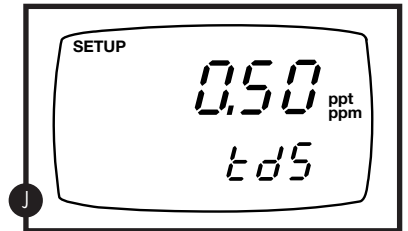

6. Calculate the TDS factor of your solution. See Appendix 2 on page 49 for information on how to calculate the TDS factor.
7. Press the ▲ and ▼ keys to select your calculated TDS conversion factor.
8. Press the ENTER key to confirm selection and to return to the subgroup menu. Press the CAL/MEAS key to return to measurement mode.

6.9 P8.0: Temperature Settings

P8.1 Selecting the temperature coefficient

The temperature coefficient is the amount of change in conductivity per degree of temperature; it is expressed in percent per °C or °F. Entering the exact temperature coefficient of your solution lets you accurately compensate temperature for almost any solution*. You can adjust 0.0 to 10.0% per °C or °F. Meter default is 2.1% per °C or °F.

From measurement mode

1. Press the Mode key to select conductivity or TDS measurement mode.
2. Press Setup key to enter Set Up mode.
3. Press the ▲ and ▼ keys to scroll through subgroups until you view parameter P8.0.

See figure **A**

4. Press the ENTER key to select parameter 8.1. The display shows “T.CO” on the upper display.

See figure **B**

5. Press the ENTER key again.. The upper display shows the temperature coefficient and the lower display shows “T.CO”.

See figure **C**

6. Press the ▲ and ▼ keys to select the temperature coefficient of your solution.
7. Press the ENTER key to confirm selection and to proceed to step 4 of P8.2. Press the CAL/MEAS key twice to return to measurement mode.

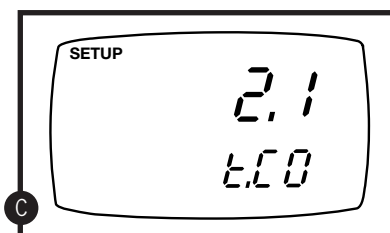
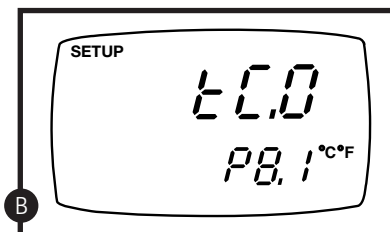
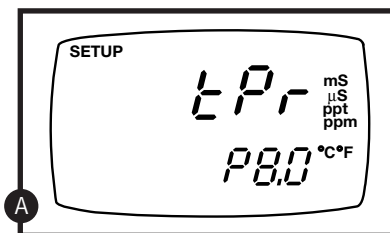

P8.2 Selecting the normalization temperature

Your meter will normalize its conductivity measurements to a standard temperature that you can select. You can adjust the normalization temperature from 15 to 30°C (59 to 86°F). Meter default is 25°C (77°F).

From measurement mode

1. Press the Mode key to select conductivity or TDS measurement mode.
2. Press Setup key to enter Set Up mode.
3. Press the ▲ and ▼ keys to scroll through subgroups until you view parameter P8.0.

See figure **D**

4. Press the ENTER key three times to select parameter 8.2. The display shows “t.nr” on the upper display.

See figure **E**

5. Press the ENTER key again. The upper display shows the normalization temperature and the lower display shows “t.nr”.

See figure **F**

6. Press the ▲ and ▼ keys to select the normalization temperature.
7. Press the ENTER key to confirm selection and to return to the subgroup menu. Press the CAL/MEAS key to return to measurement mode.

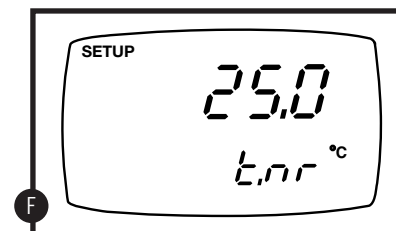
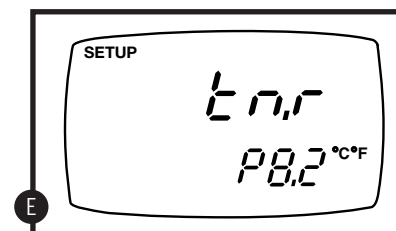
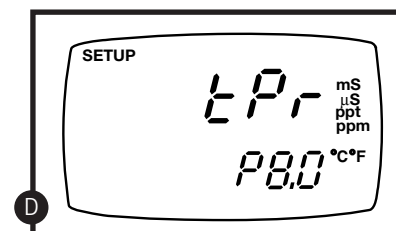

Notes

* If you do not know the temperature coefficient of your solution you can determine the correct value using the formula in Appendix 3 “Calculating Temperature Coefficients” on page 50.

6.10 P9.0: Resetting to factory default settings (conductivity/TDS)

This program lets you reset all conductivity parameters to factory default settings. This clears all calibration data any other conductivity setup functions you might have changed. The following settings will remain as you have set them:

- temperature unit of measure (°C or °F)
- The temperature offset calibration value
- All pH calibration data and parameters

From measurement mode

1. Press the Mode key to select conductivity measurement mode.
2. Press Setup key to enter Set Up mode.
3. Press the ▲ and ▼ keys to scroll through subgroups until you view parameter “P5.0” in the lower display.

See figure **A**

4. Press the ENTER key.

See figure **B**

5. Press the ▲ and ▼ keys to toggle between NO and YES.
 - NO retains current settings
 - YES resets to factory default settings
6. Press the ENTER key to confirm selection and to return to measurement mode.

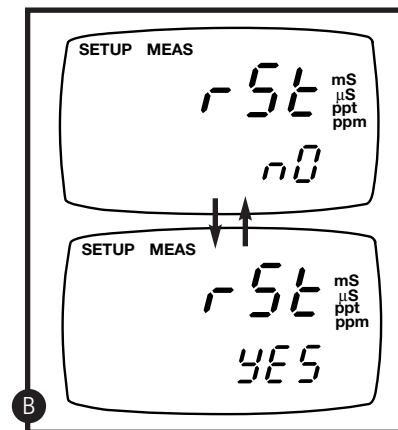
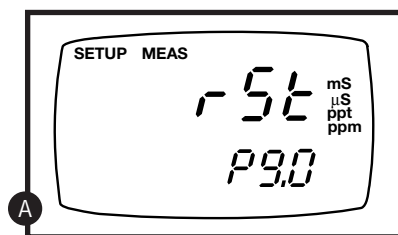

Notes

To clear all pH data, see page 31.

See page 51 for a table of factory default settings.

7. Probe Care and Maintenance

7.1 pH electrode care

Since your pH electrode is susceptible to dirt and contamination, clean it every one to three months depending on the extent and condition of use. For specialty electrode care, consult the instruction manual included with your electrode.

pH electrode storage

For best results, always keep the pH bulb wet. Use the protective electrode storage bottle or rubber cap filled with electrode storage solution to store your electrode (see page 46 for ordering information). Also, you can store in a pH 4 buffer with 1/100 part of saturated KCl. Other pH buffers are OK for storage, but NEVER use distilled water for storage.

After measuring

1. Rinse the pH electrode and reference junction in de-ionized water.
2. Store the electrode as recommended above in “pH electrode storage,” or as recommended by the manufacturer.
3. Prior to next use, rinse the liquid junction with de-ionized water and tap dry—never wipe electrode. If this does not restore electrode to normal response, see “Reactivating the pH electrode” section below.

pH electrode cleaning

Salt deposits: dissolve the deposits by immersing the electrode in tap water for ten to fifteen minutes. Ten thoroughly rinse with distilled water.

Oil/grease film: wash electrode pH bulb gently in some detergent and water. Rinse electrode tip with distilled water or use a general purpose electrode cleaner (see page 40 for ordering information).

Clogged reference junction: heat a diluted KCl solution to 60 to 80°C. Place the sensing part of the electrode into the heated solution for about 10 minutes. Allow the electrode to cool in some unheated KCl solution.

Protein deposits: prepare a 1% pepsin solution in 0.1 M of HCl. Set the electrode in the solution for five to ten minutes. Rinse the electrode with distilled water.

Reactivating the pH electrode

If stored and cleaned properly, your pH electrode should be ready for immediate use. However, a dehydrated bulb may cause sluggish response. To rehydrate the bulb, immerse the electrode in a pH 4 buffer solution for 10 to 30 minutes. If this fails, the electrode requires activation. Never touch or rub glass bulb. Contact builds up an electrostatic charge.

CONTINUED ON NEXT PAGE

pH electrode activation (for glass bodied electrodes only)

WARNING: Only qualified persons proficient with the safe handling of dangerous chemicals should perform the procedure below. Provide proper containers, fume hoods, ventilation, and waste disposal. Safety goggles and protective clothing must be worn while performing this procedure. If possible, replace with another electrode instead of performing this reactivation procedure.

1. Dip or stir the pH electrode in alcohol for 5 minutes.
2. Leave the electrode in tap water for 15 minutes.
3. Dip and stir the electrode in concentrate acid (such as HCl or H₂SO₄) for 5 minutes.
4. Repeat step 2.
5. Dip and stir in strong base (NaOH) for five minutes.
6. Leave for 15 minutes in distilled or deionized water.
7. Now test with standard calibration buffer solutions to see if the electrode yields acceptable results. You may repeat step 3 through 6 up to three times for better response. If the response does not improve, then your electrode is no longer functioning. Replace with a new electrode—call your OAKTON Distributor for more information.

7.2 Conductivity/TDS probe care

Keep the conductivity/TDS probe clean. Rinse the probe twice, and gently swirl it while you take readings. For best accuracy, soak a dry probe for at least 5 to 10 minutes or longer before calibration. Rinse the probe with deionized or tap water before storing. Never scratch the platinum portions with a hard substance. Do not strike the probe against any hard surface.

Do not make continuous contact with your solutions. Readings will rise over a period of time while you soak your probe.

Do not immerse the probe in oily solutions. Clean the electrode thoroughly by stirring it in a mild detergent bath or isopropyl alcohol. Wipe the probe with a soft tissue paper. Rinse thoroughly in tap water and then in deionized water. Recalibrate the meter after cleaning the probe.

The conductivity/TDS probe included with your meter features a removable probe guard to make cleaning easy.

To remove probe guard:

1. Grip yellow probe guard and twist clockwise. The locking notch will release.
2. Slide probe guard off end of probe.

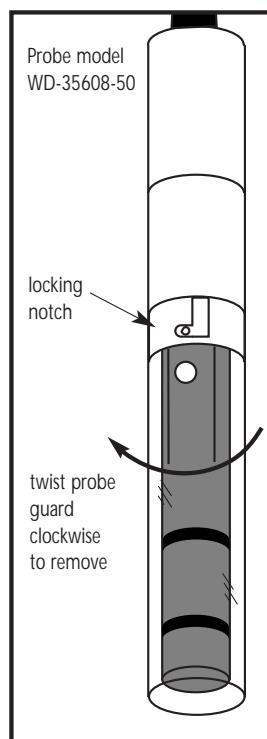

8. Troubleshooting

Problem	Cause	Solution
Power on but no display	a) Batteries not in place. b) Batteries not in correct polarity (+ and -). c) Weak batteries.	a) Check that batteries are in place and making good contact. b) Reinsert batteries with correct polarity. c) Replace batteries.
Not responding to key press	a) HOLD mode in operation. b) Damaged key pad. c) Internal program error.	a) Cancel HOLD mode. b) Return to dealer. c) Reset all internal programs by reinserting batteries.
Unstable readings	a) Air bubbles in probe. b) Dirty probe. c) Probe not deep enough in sample. d) External noise pickup or induction caused by nearby electric motor. e) Broken probe.	a) Tap probe to remove bubbles. b) Clean the probe and recalibrate. c) Make sure sample entirely covers the probe sensor(s). d) Move or switch off interfering motor. e) Replace probe. See page 46.
"OR" on upper display	a) Probe is shorted. b) Probe is in an out-of range solution. c) Broken probe.	a) Test probe. Make sure probe is fully connected to meter. b) Use different solution. c) Replace probe. See page 46.
Temperature reading erratic or lower display reads "OR"	a) Temperature of solution is out of range	a) Heat or cool solution.
Slow response	a) Dirty/Oily probe.	a) Clean probe. See "Probe Care & Maintenance", pages 41-42.

9. Error Messages

LCD Display	Indicates	Cause	Solution
Err annunciator	Unrecognized input from keypad	Wrong input in selected mode.	Release key. Select valid operations depending on mode.
CAL & Err annunciators blink	Calibration error	Wrong value input at calibration. Dirty probe.	Check your input value, clean probe. See Calibration sections or Probe Maintenance section.
Battery indicator blinks	Low battery level	Need new batteries or battery connection is bad.	Clean battery contacts. Replace batteries with fresh ones, noting polarity.

If error persists, or the meter shows incorrect values, return the meter. See “Warranty” and “Return of Items” on page 52.

For a complete diagram of the display, see page 4.

10. Specifications

Mode	pH	Temperature	Conductivity	TDS
Range	-2.00 to 16.00 pH	0 to 100°C / 32.0 to 212.0°F	0 to 19.99 µS 0 to 199.9 µS 0 to 1999 µS 0 to 19.99 mS 0 to 199.9 mS	0.00 to 9.99 ppm 10.0 to 99.9 ppm 100 to 999 ppm 1.00 to 9.99 ppt 10.0 to 199.9 ppt
Resolution	0.01 pH	0.1°C or °F	0.01 µS, 0.1 µS, 1 µS, 0.01 mS, 0.1 mS	0.01 ppm, 0.1 ppm, 1ppm, 0.01 ppt, 0.1 ppt
Accuracy	±0.01 pH	±0.5°C / ±0.9°F	±1% full scale	±1% full scale
Calibration	up to 5 points (pH 1.68, 4.01, 7.00, 10.01, 12.45)	offset in 0.1° increments up to 5°	up to 5 points (one point per range)	up to 5 points (one point per range)

pH slope: 80 to 110%

Conductivity cell constant: K = 1.0

Conductivity/TDS temperature coefficient: adjustable from 0.0 to 10.0% per °C

Conductivity/TDS normalization temperature:
adjustable from 15 to 30°C / 59 to 86°F

Conductivity-to-TDS conversion factor: adjustable from 0.4 to 1.0

Temperature compensation: automatic or manual from 0 to 100°C / 32 to 212°F

Display: dual LCD

Operating temperature: 0 to 50°C / 32 to 122°F

Power: four 1.5 V AAA batteries (included)

Battery life: > 200 hours continuous use

Probe connectors:

pH/mV: BNC connector

Conductivity/TDS/Temperature: notched six-pin connector

Dimensions:

Meter: 7.5"L x 3.5"W x 1.75"H
(19.1 cm x 8.9 cm x 4.5 cm)

Boxed: 9.2"L x 9.2"W x 2.75"H
(23 cm x 23 cm x 7 cm)

Probe: 6.8"L x 1.3" dia (17.3 cm L x 3.2 cm dia)

Weight:

Meter: 1.0 lb (0.5 kg)

Boxed: 2.0 lbs (0.9 kg)

11. Accessories

Meters

WD-35631-00 pH/CON 300 meter. Includes pH electrode, conductivity probe with built-in ATC element, batteries, and instructions

WD-35631-30 pH/CON 300 meter kit. Includes meter, pH electrode, conductivity probe with built-in ATC element, calibration solution pouches (three each of pH 4.01, 7.00, 10.00 and two each of conductivity 447 μ S, 1413 μ S, 2764 μ S, and 15,000 μ S), three rinse water pouches, sample bottle, batteries, and instructions, all in a hard shell carrying case.

Probes

WD-35801-00 Replacement pH electrode, BNC connector, epoxy body, single-junction, 145 mm L x 12 mm diameter, 3-ft cable (0.5 lb)

WD-35608-50 Replacement conductivity probe, notched 6-pin connector, built-in temperature element, K = 1.0, 127 mm L x 16 mm dia, 3 -ft cable (0.5 lb)

WD-35805-01 pH electrode, BNC connector, epoxy body, double junction, 146 mm L x 12 mm diameter, 3 ft cable (0.5 lb)

WD-35618-05 Temperature probe with notched 6-pin connector

WD-35808-71 “All-in-One” combination pH/temperature probe, with BNC connector and notched 6-pin connector, single junction, sealed, 145 mm L x 12 mm diameter (0.5 lb)

WD-00653-04 Electrode storage solution, 1 pint bottle. Keeps electrode bulb moist for faster, more accurate readings. (1.1 lbs)

WD-00653-06 Electrode cleaning solution, 1 pint bottle. Removes buildup from electrodes and maintains electrode sensitivity. (1.1 lbs)

OAKTON pH calibration solution bottles

pH solutions have ± 0.01 pH accuracy at 25°C. Shpg wt 1.1 lb (510 g).

WD-00654-01 pH 1.68 calibration buffer, 1 pint.

WD-00654-00 pH 4.01 calibration buffer, 1 pint.

WD-00654-04 pH 7.01 calibration buffer, 1 pint.

WD-00654-08 pH 10.01 calibration buffer, 1 pint.

WD-00654-12 pH 12.45 calibration buffer, 1 pint.

OAKTON “Singles” pH calibration solution pouches

pH solutions have ± 0.01 pH accuracy at 25°C. Shpg wt 1.1 lb (510 g) per box.

WD-35653-00 Deionized rinse water solution pouches, 20/box.

WD-35653-01 pH 4.01 calibration buffer solution pouches, 20/box.

WD-35653-02 pH 7.00 Calibration buffer solution pouches, 20/box.

WD-35653-03 pH 10.00 Calibration buffer solution pouches, 20/box.

WD-35653-04 Assortment pack, 5 each deionized water, pH 4.01, pH 7.00, and pH 10.00 solution pouches.

OAKTON conductivity/TDS calibration solution bottles

Our solutions come in 1 pint recyclable PE bottles. $\pm 1\%$ accuracy at 25°C.

Model No.	Solution type	Conductivity-to-TDS calibration values		
		ppm KCl	ppm NaCl	ppm 442
WD-00653-16	84 μ S	40.38	38.04	50.50
WD-00653-47	447 μ S	225.6	215.5	300.0
WD-00653-18	1413 μ S	744.7	702.1	1000
WD-00653-15	1500 μ S	757.1	737.1	1050
WD-00653-89	8974 μ S	5101	4487	7608
WD-00606-10	12,880 μ S	7447	7230	11,367
WD-00653-50	15,000 μ S	8759	8532	13,455
WD-00653-32	80 mS	52,168	48,384	79,688

OAKTON conductivity/TDS calibration solution pouches

Each pouch contains 20 ml of fresh, premixed calibration solution—guarantees uncontaminated solution for every use. $\pm 1\%$ accuracy at 25°C. 20 pouches/box. Shpg wt 1.1 lb (510 g).

Model No.	Solution type	Conductivity-to-TDS calibration values		
		ppm KCl	ppm NaCl	ppm 442
WD-35653-10	447 μ S	225.6	215.5	300.0
WD-35653-11	1413 μ S	744.7	702.1	1000
WD-35613-13	15,000 μ S	8759	8532	13,455

WD-35653-00 Deionized rinse water pouches. 20 pouches/box.

To order OAKTON accessories, contact your OAKTON distributor.

12. Appendix 1: Conductivity to TDS Conversion Factors

1. Factor—the conductivity to ppm TDS conversion factor. Multiply conductivity by this factor to get ppm TDS for the type of TDS reading needed.
2. 442—a formulation that most closely represents the conductivity to ppm relationship, on average, for naturally occurring fresh water.
3. TDS Your Material—These columns are for you to write in your application-specific conductivity-to-ppm values and conversion factors for future reference.

Factor = actual TDS ÷ Actual Conductivity @ 25°C

Conductivity at 25°C	TDS KCl ppm Value	TDS KCl Factor ¹	TDS NaCl ppm Value	TDS NaCl Factor ¹	TDS 442 ² ppm Value	TDS 442 ² Factor ¹	TDS Your Material ³ ppm Value	TDS Your Material ³ Factor
84 µS	40.38	0.5048	38.04	0.4755	50.50	0.6563		
447 µS	225.6	0.5047	215.5	0.4822	300.0	0.6712		
1413 µS	744.7	0.5270	702.1	0.4969	1000	0.7078		
1500 µS	757.1	0.5047	737.1	0.4914	1050	0.7000		
8974 µS	5101	0.5685	4487	0.5000	7608	0.8478		
12880 µS	7447	0.5782	7230	0.5613	11,367	0.8825		
15000 µS	8759	0.5839	8532	0.5688	13,455	0.8970		
80 mS	52,168	0.6521	48,384	0.6048	79,688	0.9961		

13. Appendix 2: Calculating TDS Conversion Factors

You can calibrate your meter using TDS calibration standard solutions. The calibration standard only needs to give the TDS value at a standard temperature such as 25°C. To determine the conductivity-to-TDS conversion factor use the following formula:

$$\text{Factor} = \text{Actual TDS} \div \text{Actual Conductivity @ 25°C}$$

Definitions:

Actual TDS: Value from the solution bottle label or as a standard you make using high purity water and precisely weighed salts.

Actual Conductivity: Value measured using a properly calibrated Conductivity/Temperature meter.

Both the Actual TDS and the Actual Conductivity values must be in the same magnitude of units. For example, if the TDS value is in ppm the conductivity value must be in µS; if the TDS value is in ppt the conductivity value must be in mS.

Check your factor by multiplying the conductivity reading by the factor in the above formula. The result should be the TDS value.

14. Appendix 3: Calculating Temperature Coefficients

To determine the temperature coefficient of your sample solution use this formula:

$$TC = 100 \times \frac{C_{T_2} - C_{T_1}}{C_{T_1}(T_2 - 25) - C_{T_2}(T_1 - 25)}$$

TC = Temperature coefficient

C_{T_1} = Conductivity at Temp. 1 C_{T_2} = Conductivity at Temp. 2

T_1 = Temp. 1 T_2 = Temp. 2 25 = 25°C

NOTE: A controlled temperature water bath is ideal for this procedure.

- Immerse the probe into a sample of your solution and adjust the temperature coefficient to 0% (that is, no compensation) by performing the following:
 - From conductivity measurement mode, press the SETUP key.
 - Press the ▲ key until the lower display reads P8.0.
 - Press the ENTER key twice. The lower display reads tCO and the upper display shows the temperature coefficient value.
 - Press the ▼ key until the upper display shows 0.0.
 - Press ENTER key to confirm the value.
 - Press CAL/MEAS key twice to return to measurement mode.
- Wait for 5 minutes. Note T_1 and C_{T_1} (conductivity at T_1).
- Condition the sample solution and probe to a temperature (T_2) that is about 5°C to 10°C different from T_1 , and note the conductivity reading C_{T_2} .

NOTE: Record your results for future reference. Ideally T_1 and T_2 should bracket your measurement temperature, and should not differ by more than 5°C.

- Calculate the temperature coefficient of your solution according to the formula shown above.
- Enter the temperature coefficient you calculated into the meter.
 - From conductivity measurement mode, press the SETUP key.
 - Press the ▲ key until the lower display reads P8.0.
 - Press the ENTER key twice. The lower display reads tCO and the upper display shows the temperature coefficient value (should be 0, per step 1-D above).
 - Press the ▲ key until the upper display shows your calculated temperature coefficient.
 - Press ENTER key to confirm the value.
 - Press CAL/MEAS key twice to return to measurement mode.

The calculated temperature coefficient will now be applied to all the meter readings.

15. Appendix 4: Meter factory default settings

Resetting the meter to factory default settings clears all calibration data and most other setup functions you might have changed. The following settings will remain as you have set them:

- temperature unit of measure (°C or °F)
- The temperature offset calibration value

NOTE: Conductivity/TDS and pH data are cleared separately from each other.

- To clear pH data, see Sub group P4.0 on page 31
- To clear conductivity/TDS data, see Sub group P9.0 on page 40

Type	Parameter	Default	Remarks
pH parameters			
P1.1	Viewing pH	---	No calibration data for pH 1.68
P1.2	calibration data	---	No calibration data for pH 4.01
P1.3		---	No calibration data for pH 7.00
P1.4		---	No calibration data for pH 10.00
P1.5		---	No calibration data for pH 12.45
P2.1	View electrode offset	0.00 mV	No offset adjustment
P2.2	View electrode slope	100.0%	No slope adjustment
P3.1	Ready indicator	Ready on	Ready indicator on; auto endpoint off
P3.2	# pH cal. points	3	3 pH calibration points available (1-5 point range)
P3.3	°F or °C	no default	°F or °C remains as selected
P4.0	pH factory default	no	Retains your current settings
Conductivity/TDS parameters			
P5.1	Viewing con./TDS	---	No cal. data for R1 (0.00-19.99 µS/0.00-9.99 ppm)
P5.2	calibration data	---	No cal. data for R2 (0.0-199.9 µS/10.0-99.9 ppm)
P5.3		---	No cal. data for R3 (0-1999 µS/100-999 ppm)
P5.4		---	No cal. data for R4 (0.00-19.99 mS/1.00-9.99 ppt)
P5.5		---	No cal. data for R5 (0.0-199.9 mS/10.0-199.9 ppt)
P6.1	Viewing con./TDS	1.000	No offset for R1 (0.00-19.99 µS/0.00-9.99 ppm)
P6.2	calibration data	1.000	No offset for R2 (0.0-199.9 µS/10.0-99.9 ppm)
P6.3		1.000	No offset for R3 (0-1999 µS/100-999 ppm)
P6.4		1.000	No offset for R4 (0.00-19.99 mS/1.00-9.99 ppt)
P6.5		1.000	No offset for R5 (0.0-199.9 mS/10.0-199.9 ppt)
P7.1	Ready indicator	Ready on	Ready indicator on; auto endpoint off
P7.2	°F or °C	no default	°F or °C remains as selected
P7.3	ATC on or off	ATC on	—
P7.4	Set TDS factor	0.5	Adjustable from 0.4 to 1.0
P8.1	Temp. coefficient	2.1% per °C	Adjustable from 0 to 10% per °C
P8.2	Normalization temp.	25°C	Adjustable from 15 to 30°C / 59 to 86°F
P9.0	factory default	no	Retains your current settings