

OAKTON[®]
INSTRUMENTS
...setting the standard, again and again[®]

Oakton Instruments
625 East Bunker Court
Vernon Hills, IL 60061
Tel: 1-888-4OAKTON
Fax: 1-847-247-2984
info@4oakton.com
www.4oakton.com

NOVA-TECH
INTERNATIONAL

800 Rockmead Dr Ste 102 • Houston, TX 77339-2496
Tel: (281) 359-8538 • Toll Free Tel: (866) 433-6682
Fax: (281) 359-0884 • Toll Free Fax: (866) 433-6684
sales@novatech-usa.com • www.novatech-usa.com

OAKTON[®]
INSTRUMENTS

TempTestr[®] IR Food Thermometer 35625-45

Noncontact Food Safety Thermometer

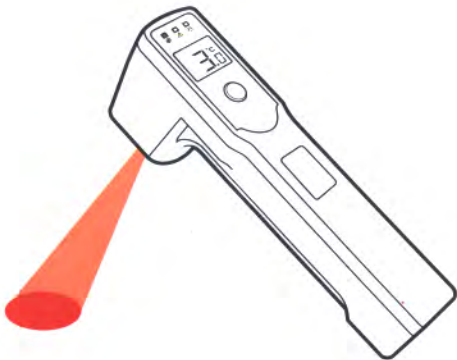

OAKTON[®]
INSTRUMENTS

HACCP Zone Indicators / Indicateur zone HACCP /
HACCP-Bereichsanzeige / Indicadores de Zona APPCC HACCP/
HACCP ゾーン表示 / HACCP 区域指示灯

C°/F° Indicator / Affichage C°/F° /
C°/F°-Anzeige / Indicador °C/°F /
Indicador °C/°F / 温度表示 (C°) /
C°/F° 指示灯

Low Battery Icon / Icône Etat des piles /
Batteriezustandsanzeige / Icono de Bateria
Baja / Ícone de bateria com carga baixa /
バッテリー アイコン / 電池電 量不足 图标

ON (Measure) / ON (Mesure) / ON (Messen) /
ON (Medición) / ON (medida) / 测温 ボタン /
ON (測量)

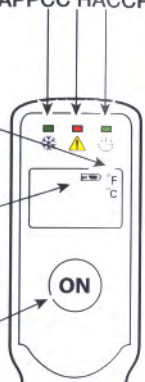

Target Illumination / Eclairage de la cible Optique /
Messfleckbeleuchtung / Iluminación del Objetivo /
Iluminação alvo マーカー (照準) / 目标照明

Window for IR Optics / Sonde /
Infraoptique / Ventana de Óptica IR/
Janela para óticos IR /
红外测
量窗口
レンズ

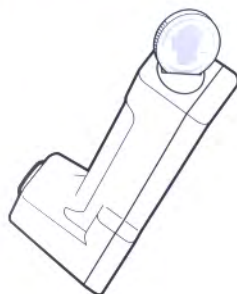
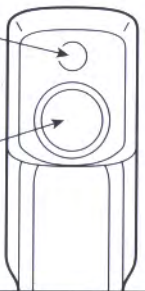

Battery Type
AA ANSI/NEDA

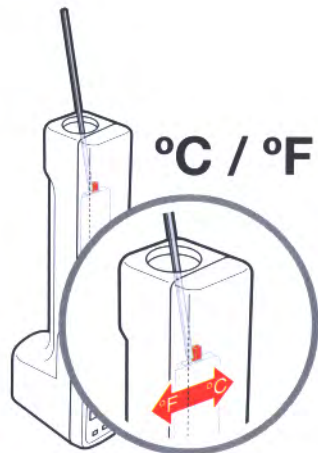
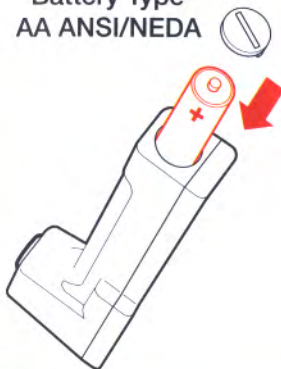

HACCP ✓

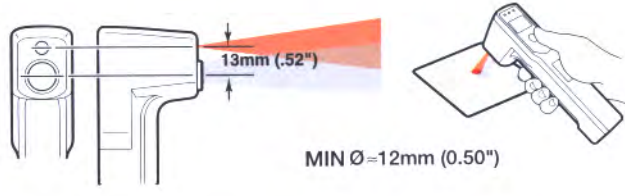
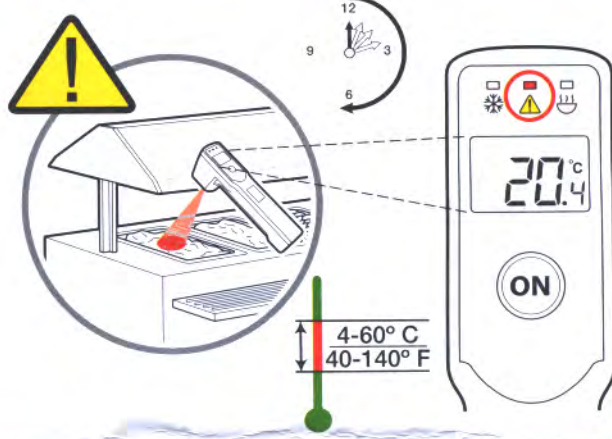
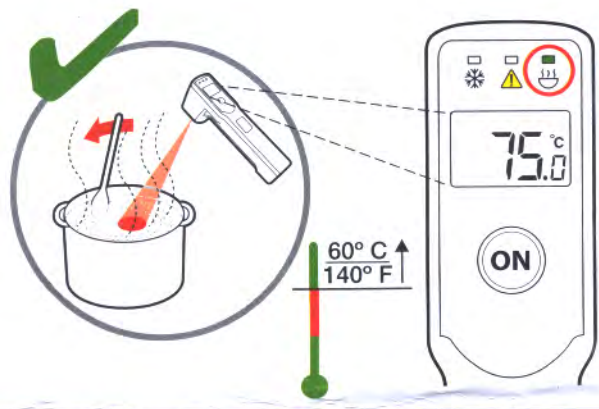
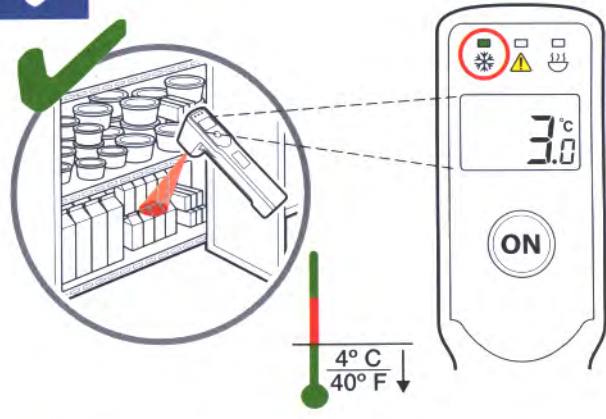
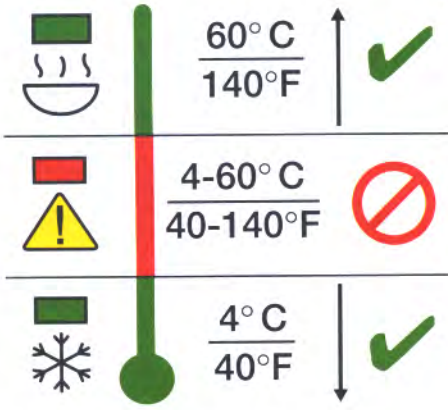

1°C - 4°C
(34°F - 39°F)

1°C - 4.5°C
(34°F - 40°F)

0°C - 4°C
(32°F - 39°F)



14°C - 19°C
(57°F - 66°F)

9°C - 13°C
(48°F - 55°F)

4°C - 8°C
(39°F - 46°F)

MIN

MAX

2°C - 4°C
(36°F - 39°F)



≤ -20°C (-5°F) -18°C (0°F) - 12°C (10°F) 15°C (59°F) - 20°C (68°F)

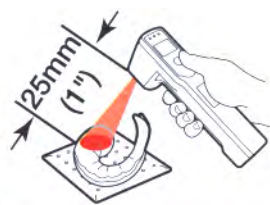

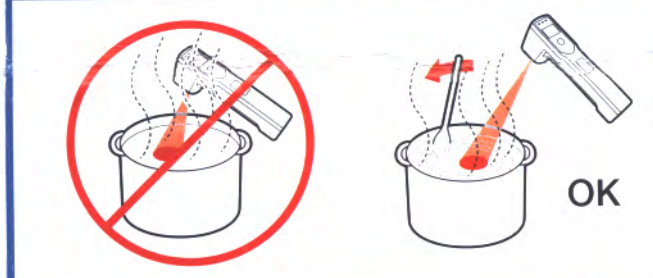
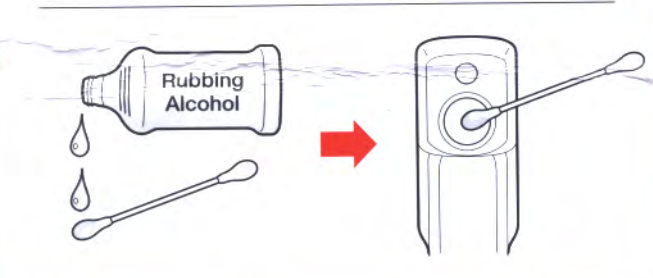
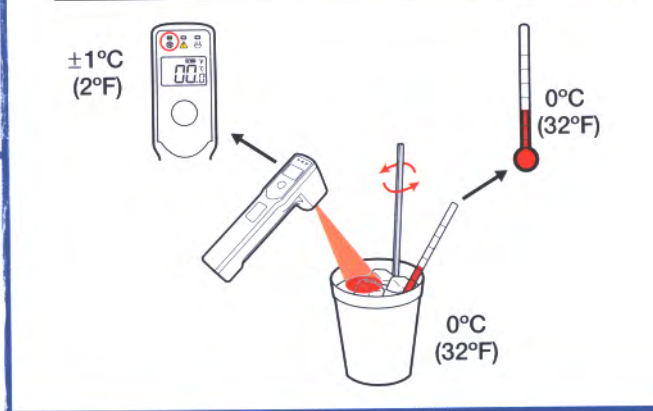
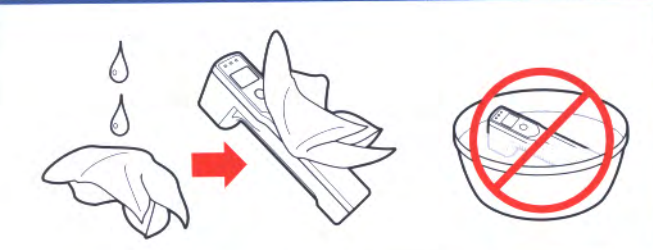
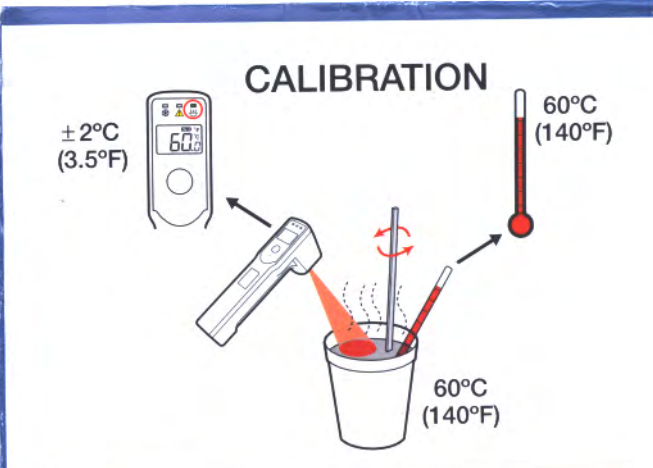
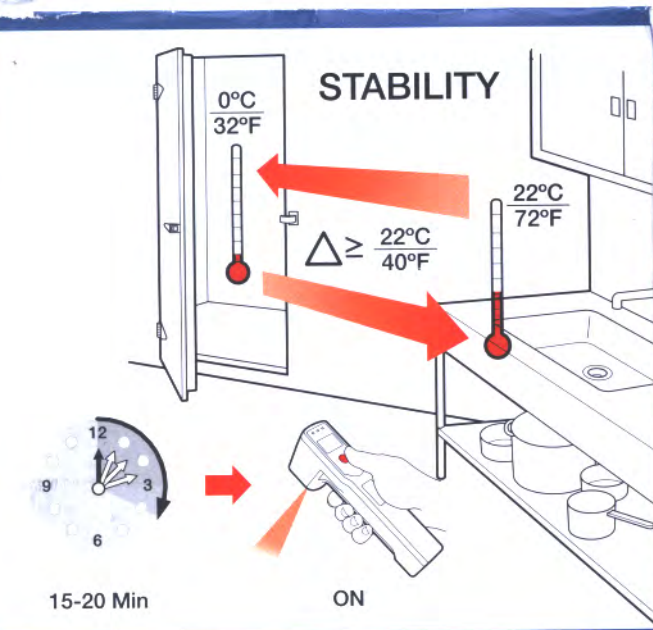

Temperature Range	Temperaturbereich	Echelle de mesure	Range de Temperatura	Rango de Temperatura	温度范围	測定温度範囲	-30°C to 205°C (-22°F to 400°F)
Accuracy	Genauigkeit	Précision	Precisão	Precisión	精度	測定精度	Between 0°C and 65°C (32°F to 150°F): ±1°C (±2°F) Below 0°C (32°F): ±1°C (±2°F) ±0.1 degree Above 65°C (150°F): ±1.5% of reading
Assumes ambient operating temperature of 23°C ±2°C (73°F ±4°F)	bei einer Umgebungstemperatur von 23°C ± 2K	par 23°C ± 2K ambient	Assume a temperatura operacional ambiente de 23°C ±2°C (73°F ±4°F)	Suponiendo Temperatura Ambiente de Operación de 23°C ±2°C (73°F ±4°F)	环境温度23°C ±2°C 或73°F ±4°F	(23°C ±2°Cでの値)	
Response Time	Ansprechzeit	Temps de réponse	Tempo de Resposta	Tiempo de Respuesta	响应时间	応答速度	<500ms after initial reading
Spectral Response	Spektrale Empfindlichkeit	Réponse spectrale	Resposta Espectral	Respuesta Espectral	响应波长	応答波長	8-14 microns
Emissivity	Emissionsgrad	Emissivité	Emissividade	Emissividad	放射率	放射率補正	Pre-set for Food Service Applications
Optical Resolution (D-S)	Optische Auflösung (E-M)	Résolution optique (D-S)	Resolução Óptica (D-S)	Resolución Óptica (D-S)	光学分辨率 (D:S)	D:S比	2.5:1 @ 90% energy, typical
Typical Working Range (target illumination)	Typische Messentfernung (Messfleckbeleuchtung)	Distance de mesure classique (Eclairage de la cible)	Range de Operação Típica (iluminação do alvo)	Rango típico de Aplicación (iluminación del objetivo)	典型的工作范围 (目标照明)	標準測定距離	~25mm to 250mm (~1" to 10")
Repeatability	Reproduzierbarkeit	Reproductibilité	Repetibilidade	Repetibilidad	重复性	反復精度	Within accuracy specifications of the unit
Ambient Operating Range	Umgebungstemperaturbereich	Température ambiante	Range Operacional do Ambiente	Temperatura Ambiente de Operación	操作环境温度	動作環境温度	0°C to 50°C (32°F to 122°F)
Relative Humidity	Relative Luftfeuchte	Humidité relative	Umidade Relativa	Humedad Relativa	相应湿度	相對湿度	90% (±5%) RH noncondensing @ 30°C (86°F)
Storage Temperature	Lagertemperatur	Température de stockage	Temperatura de Armazenamento	Temperatura de Armazenamiento	儲存温度	保存温度	-20°C to 60°C (-4°F to 140°F)
Weight/Dimensions (with battery)	Abmessungen Masse (inklusive Batterien)	Dimensions Masse (avec les piles)	Peso/Dimensões (com bateria)	Peso/Dimensiones (con batería)	重量/尺寸 帶 (電池)	重量/寸法	150mm x 30mm x 50mm (5.88" x 1.25" x 2") 150g (0.33lbs)
Power	Spannungsversorgung	Alimentation	Alimentação	Alimentación	電源	電源	1 AA alkaline battery
Battery Life	Batterielebensdauer	Autonomie des piles	Durabilidade da Bateria	Duración de la Bateria	電池寿命	バッテリー駆動時間	10 hours minimum @ 23°C (73°F)
Display Resolution	Anzeigenaufösung	Résolution d'indication de température	Resolução do Display	Resolución en Pantalla	显示分辨率	表示分辨率	4 digits, 0.2°C (0.5°F)
Display Hold	Anzeigenhaltezeit	Durée d'affichage	Espera do Display	Retención de Lectura	显示保持	ホールド時間	7 sec
Standards	Standards	Standards	Padrões	Estándares	标准	適合規格	Conforms to: • EN61326-1 Electromagnetic Emissions and Susceptibility, Criteria B • EN61010-1 General Safety IP54 Sealing (hand washable, non-submersible)
Environmental Sealing	Schutzgrad	Degré de protection	Vedação Ambiental	Sellado Ambiental	环境密封	保護等級	
Minimum Target Size	Kleinste Messfleckgröße	Taille minimale du spot	Tamanho Mínimo do Alvo	Tamaño Mínimo de Objetivo	最小目标尺寸	最小スポットサイズ	~12mm (~0.5")
Illumination to IR Channel Offset	Offset: Messkanal zu Beleuchtung	Offset: canal infrarouge pour éclairage	Iluminação para o Deslocamento do Canal IV	Desalineación Entre Canales de Iluminación e Infrarrojo	照明与IR的偏差	標準中心軸オフセット	13mm (0.52")
Certifications	Zertifizierung	Certification	Certificado	Certificaciones	认证	認證	CE