

18. Warranty

OAKTON warrants this meter to be free from significant deviations in material and workmanship for a period of three years from date of purchase. OAKTON warrants this probe to be free from significant deviations in material and workmanship for a period of six months from date of purchase. If repair or adjustment is necessary and has not been the result of abuse or misuse within the warranted time period, please return—freight prepaid—and correction will be made without charge. OAKTON alone will determine if the product problem is due to deviations or customer misuse.

Out-of-warranty products will be repaired on a charge basis.

19. Return of items

Authorization must be obtained from our Customer Service Department before returning items for any reason. When applying for authorization, please include data regarding the reason the items are to be returned. For your protection, items must be carefully packed to prevent damage in shipment and insured against possible damage or loss. We will not be responsible for damage resulting from careless or insufficient packing. A restocking charge will be made on all unauthorized returns.

NOTE: We reserve the right to make improvements in design, construction, and appearance of products without notice.

NOVA-TECH
INTERNATIONAL
800 Rockmead Dr Ste 102 • Houston, TX 77339-2112
Tel: (281) 359-8538 • Toll Free Tel: (866) 433-6682
Fax: (281) 359-0084 • Toll Free Fax: (866) 433-6684
sales@novatech-usa.com • www.novatech-usa.com

OAKTON®

OPERATING INSTRUCTIONS

OAKTON® 35608-Series

Portable Waterproof Conductivity Meter

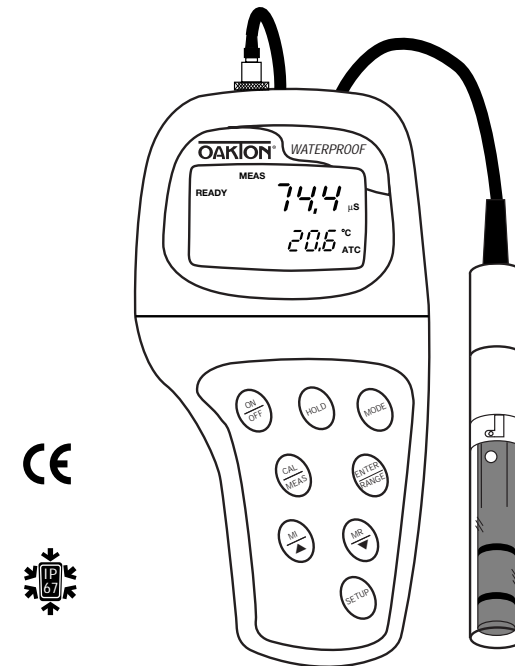

Printed in the U.S.A. 4/99

OAKTON®

Table of Contents

1. Introduction.....	4	7.6 <u>Program 5.0: Temperature</u>	35-36
2. Display and keypad functions	5-6	P5.1 Adjusting the temperature coefficient	35
2.1 Display	5	P5.2 Adjusting the normalization temperature	36
2.2 Keypad	6	7.7 <u>Program 6.0: Selecting the cell constant</u>	37
3. Preparation	7-9	7.8 <u>Program 7.0: Setting the real-time clock</u>	38-39
3.1 Inserting the batteries	7	7.9 <u>Program 8.0: Resetting to factory defaults</u>	40
3.2 Probe information	8	8. Probe care and maintenance.....	41
3.3 Connecting the probe to the meter	9	9. Troubleshooting.....	42
4. Calibration	10-16	10. Error Messages.....	43
4.1 Important information on meter calibration	10	11. Specifications	44
4.2 Preparing the meter for calibration	11	12. Accessories	45-46
4.3 Conductivity calibration.....	12-13	13. Addendum 1: Calibration tips	47
4.4 TDS calibration.....	14-15	14. Addendum 2: Conductivity to TDS conversion factors	48
4.4.1 Calibrating for TDS directly	14	15. Addendum 3: Calculating TDS Conversion factors	49
4.4.2 Calibration with conductivity standard and TDS factor	15	16. Addendum 4: Calculating temperature coefficients.....	50
4.5 Temperature calibration.....	16	17. Addendum 5: Meter factory default settings	51
5. Measurement	17-22	18. Warranty.....	52
5.1 Automatic Temperature Compensation	17	19. Return of Items.....	52
5.2 Manual Temperature Compensation.....	18-19		
5.3 Taking Measurements	20		
5.4 Using manual ranging function.....	21		
5.5 Hold function.....	22		
6. Memory and data input functions	23-24		
6.1 Memory Input.....	23		
6.2 Memory Recall.....	24		
7. SETUP functions	25-40		
7.1 <u>Set Up mode overview</u>	26-27		
7.2 <u>Program 1.0: Memory clear</u>	28		
7.3 <u>Program 2.0: Viewing calibration data</u>	29		
7.4 <u>Program 3.0: Viewing probe data</u>	30		
7.5 <u>Program 4.0: Unit configuration</u>	31-34		
P4.1: READY indicator and auto endpoint function.....	31		
P4.2: Selecting °C or °F	32		
P4.3 Selecting Automatic or Manual Temperature Compensation.....	33		
P4.4 Setting the TDS factor (TDS 400 and CON 410 meters only).....	34		

1. Introduction

Thank you for selecting an OAKTON waterproof portable meter. This meter is a microprocessor-based instrument that is completely waterproof—and it floats! Your meter features a built-in real time clock, expanded memory, and many other user-friendly features, all of which are accessible through the membrane keypad. You have one of three models:

- CON 400 meter: reads conductivity and temperature
- TDS 400 meter: reads TDS and temperature
- CON 410 meter: reads conductivity, TDS and temperature

Your meter includes a model WD-35608-50 Ultem/Stainless Steel cell (cell constant K = 1.0) and batteries.

Please read this manual thoroughly before operating your meter.

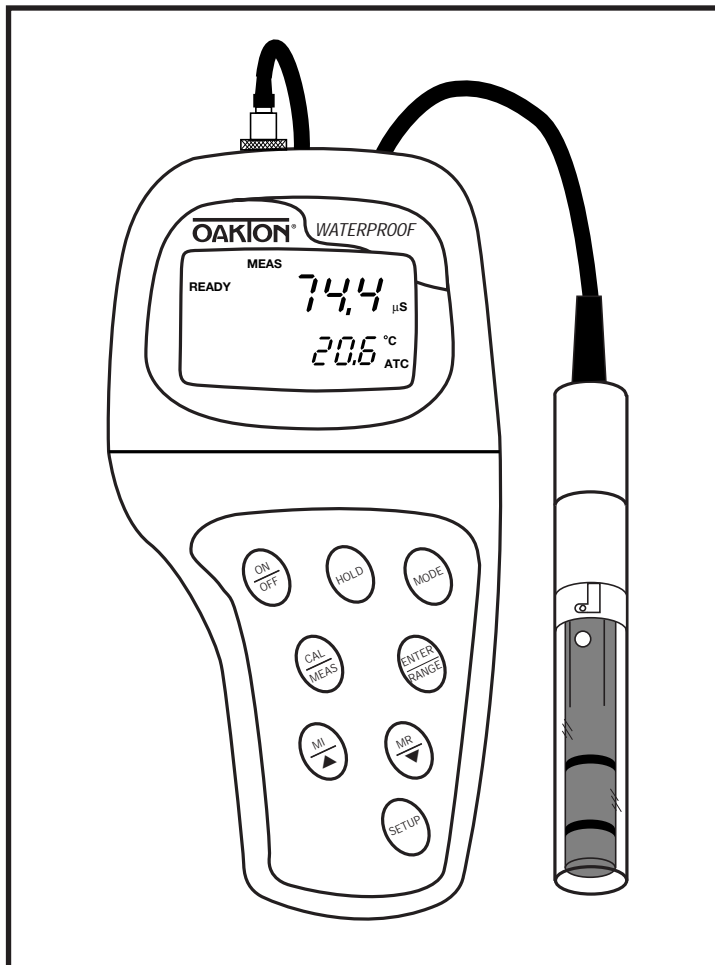

2. Display and Keypad Functions

2.1 Display

The LCD has a primary and secondary display.

- The primary display shows the measured conductivity or TDS reading.
- The secondary display shows the temperature of the reading.

The display also shows error messages, keypad functions and program functions.

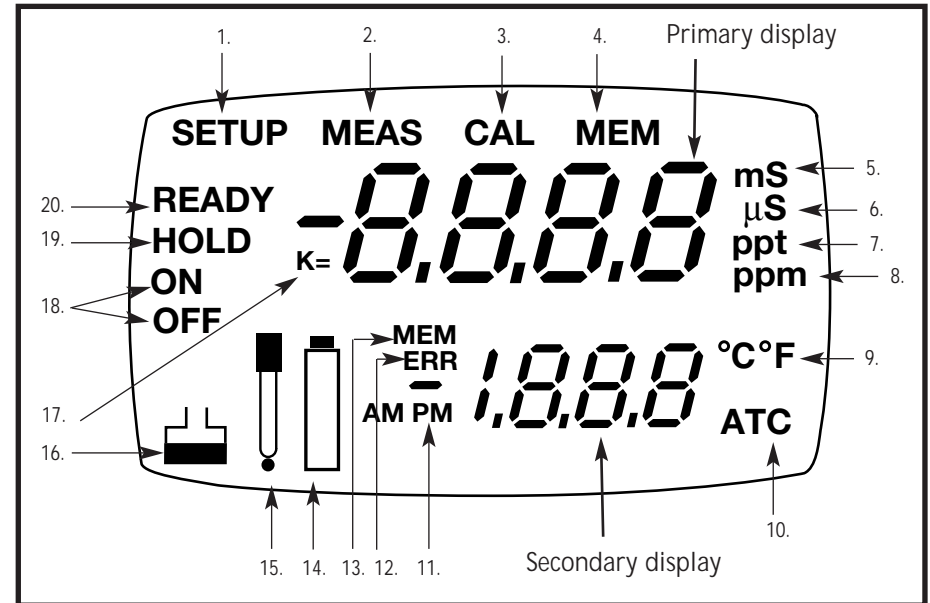

- | | | |
|---|---|------------------------------------|
| 1. SETup mode indicator | 7. parts per thousand indicator (TDS 400 and CON 410 meters only) | 13. MEMory location indicator |
| 2. MEASurement mode indicator | 8. parts per million indicator (TDS 400 and CON 410 meters only) | 14. Low battery indicator |
| 3. CALibration indicator | 9. Temperature indicator | 15. Probe indicator |
| 4. MEMory recall mode indicator | 10. Automatic Temperature Compensation indicator | 16. Calibration solution indicator |
| 5. millisiemens indicator (CON 400 and CON 410 meters only) | 11. Clock indicator | 16. Function ON/OFF indicator |
| 6. microsiemens indicator (OCN 400 and CON 410 meters only) | 12. ERRor indicator | 17. Cell constant indicator |
| | | 18. On/off indicator |
| | | 19. HOLD indicator |
| | | 20. READY indicator |

2.2 Keypad

The large membrane keypad makes the instrument easy to use. Each button, when pressed, has a corresponding graphic indicator on the LCD.

ON/OFFPowers and shuts off the meter.

HOLDFreezes the measured reading. To activate, press HOLD while in measurement mode. To release, press HOLD again.

MODEPress to select the measurement parameter.
CON 400 meter: Toggles between conductivity and time
TDS 400 meter: Toggles between TDS and time
CON 410 meter: Toggles between conductivity, TDS and time

CAL/MEASToggles user between Calibration and Measurement mode.
NOTE: Temperature calibration is available from conductivity calibration mode; see page 16 for directions.

ENTER/RANGE..ENTER function: Press to confirm values in Calibration mode and to confirm selections in Setup mode.
RANGE function: Press to enter manual ranging function.
The MEAS indicator blinks while in manual ranging function.

▲ / ▼Calibration mode: ▲ /▼ scrolls through calibration values.
Setup mode: ▲ /▼ scrolls through subgroups and program options.

MI / MRMI/MR work in the measurement mode.
MI (memory input) stores the measured value into memory.
MR (memory recall) recalls the sets of values stored in the memory.

SET UP.....Press to enter SETUP mode. SETUP mode lets you customize meter preferences, view calibration and probe offset data, and select cell constant.

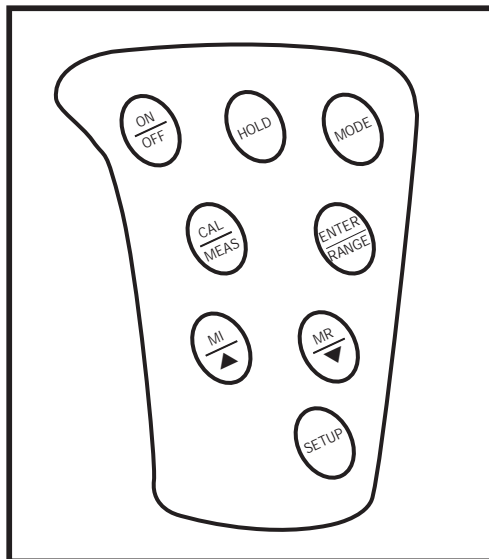

3. Preparation

3.1 Inserting the Batteries

Four AAA batteries are included with your meter.

1. Use a Phillips screwdriver to remove the two screws holding the battery cover. See figure below.
2. Lift off battery cover to expose batteries.
3. Insert batteries. Follow the diagram inside the cover for correct polarity.
4. Replace the battery cover into its original position. Screw cover back into place.

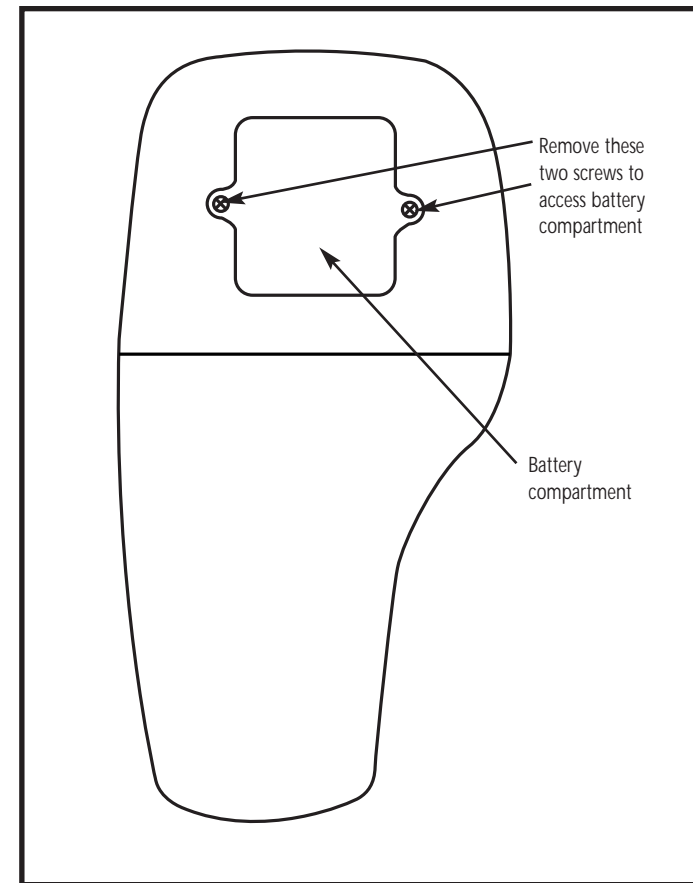

3.2 Probe information

Your OAKTON meter uses a conductivity/TDS cell with a sturdy 6-pin connector. This cell is designed for use with OAKTON waterproof meters only.

Your meter includes a model WD-35608-50 Ultem/Stainless Steel cell with a cell constant of $K = 1.0$. This conductivity/TDS cell features a built-in temperature sensor for Automatic Temperature Compensation (ATC). It has a specially designed housing that provides fast temperature response and reduces air bubble entrapment, which makes it easy to obtain accurate, stable readings.

OAKTON offers other conductivity/TDS cells with different cell constants for very high or low range readings. See the "Accessories" section on page 45 for our listing of other cells.

Wetted parts include:

1. Polyetherimide (Ultem)
2. Polybutylterphalate (Valox)
3. Stainless steel (SS 304)

NOTE: We recommend that the you do not submerge the probe above the protective yellow cap. You can submerge the cable for brief periods of time, but not continuously.

See section 8 on page 41 for probe care and maintenance information.

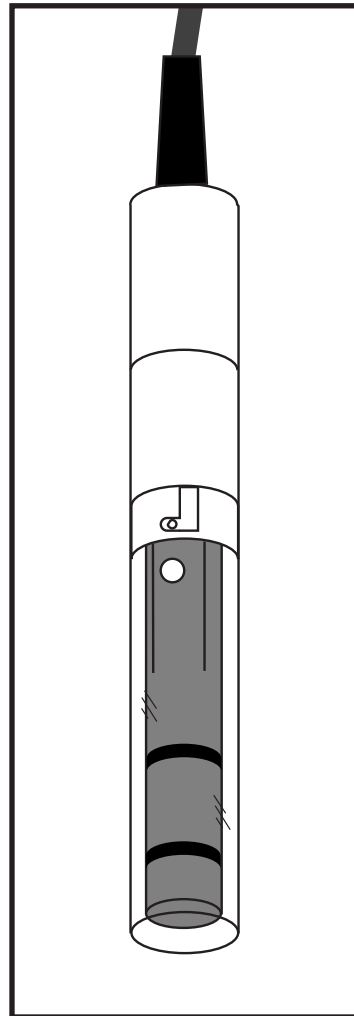

3.3 Connecting the probe to the meter

1. Line up the notch and 6 pins on the meter with the holes in the 6-pin connector. Push down and turn the locking ring clockwise to lock into place.

See figure below.

2. To remove probe, turn the locking ring counterclockwise on the probe connector. Pull probe away from the meter.

CAUTION: Do not pull on the probe cord or the probe wires might disconnect.

NOTE: Keep connectors clean. Do not touch connector with soiled hands.

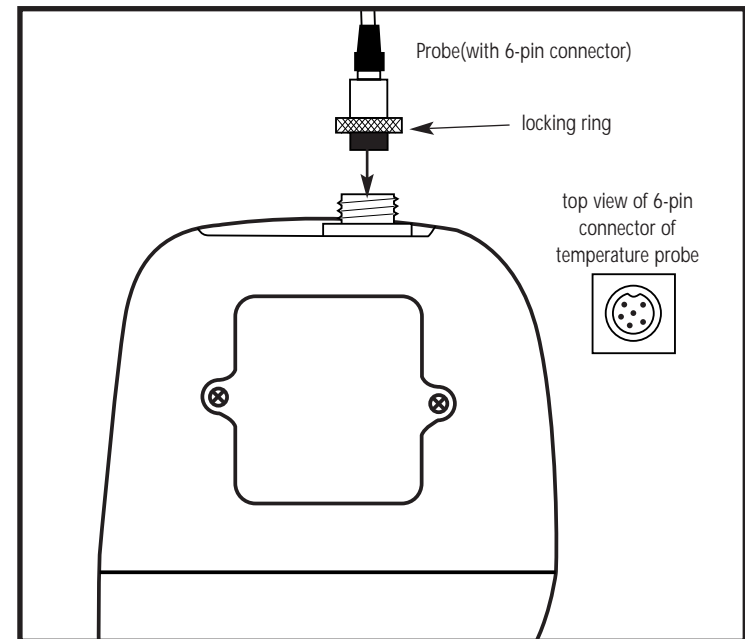

4. Calibration

4.1 Important Information on Meter Calibration

Your meter has five measuring ranges. You can calibrate at one point in each of the measuring ranges (up to five points). If you are measuring values in more than one range, make sure to calibrate each of the ranges you are measuring.

To view current calibration points, see SETUP section Program 2.0 on page 29.

IMPORTANT: You need to calibrate your meter at a standard that is a minimum of 20% of the range in which you are measuring. For example, use a minimum calibration value of 400 μS in the 0 to 1999 μS range.

The following table lists the corresponding conductivity and TDS ranges. You should calibrate each range using a solution that falls between the values in the “recommended calibration solution range” column.

Conductivity Range	Recommended Calibration Solution Range	TDS Range	Recommended Calibration Solution Range
0.00-19.99 μS	6.00 to 17.00 μS	0.00-9.99 ppm	3.00 to 8.50 ppm
0.0-199.9 μS	60.0 to 170.0 μS	10.0-99.9 ppm	30.0 to 85.0 ppm
0-1999 μS	600 to 1700 μS	100-999 ppm	300 to 850 ppm
0.00-19.99 mS	6.00 to 17.00 mS	1.00-9.99 ppt	3.00 to 8.50 ppt
0.0-199.9 mS	60.0 to 170.0 mS	10.0-200 ppt	30.0 to 170 ppt

When you recalibrate your meter, old calibrations are replaced on a range basis. For example, if you previously calibrated your conductivity meter at 1413 μS in the 0 to 1999 μS range and you recalibrate at 1500 μS (also in the 0 to 1999 μS range), the meter will replace the old calibration data (1413 μS) in that range. The meter will retain all calibration data in other ranges.

To completely recalibrate your meter, or when you use a replacement probe, it is best to clear all calibration data in memory. To erase all old conductivity and TDS calibration data completely from memory, see SETUP section Program 8.0 on page 40.

For information on how to calibrate your meter:

- See section 4.3 on pages 12-13 for Conductivity Calibration. (CON 400 and CON 410 meters only).
- See section 4.3 on pages 14-15 for TDS Calibration. (TDS 400 and CON 410 meters only).
- See section 4.4 on page 16 for Temperature Calibration.
- See Addendum 1 on page 47 for more calibration tips.

4.2 Preparing the Meter for Calibration

Before starting calibration, make sure you are in the correct measurement mode. When you switch on the meter, the meter starts up in the units you shut it off in.

For best results, select a standard value close to the sample value you are measuring. Alternatively use a calibration solution value that is approximately $\frac{1}{3}$ the full scale value of the measurement range you plan to use. For example, in the 0 to 1999 μS conductivity range, use a 1413 μS solution for calibration.

Do not reuse calibration solutions after calibration. Contaminants in the solution can affect the calibration, and eventually the accuracy of the measurements. Use fresh calibration solution each time you calibrate your meter.

NOTE: These meters are factory set to a temperature coefficient of 2.1% per $^{\circ}\text{C}$. For most applications this will provide good results. See Program P5.1 on page 35 to set the temperature coefficient to a different value. See Addendum 3, “Calculating Temperature Coefficients” on page 50 to determine the appropriate temperature coefficient for your solution.

NOTE: The factory default value for normalization temperature is 25 $^{\circ}\text{C}$. If you need to normalize to a value other than 25 $^{\circ}\text{C}$, see Program P5.2 on page 36.

4.3 Conductivity calibration

The CON 400 and CON 410 meters are capable of up to 5-point conductivity calibration at one point per conductivity range (0.00-19.99 μS ; 0.0-199.9 μS ; 0-1999 μS ; 0.00-19.99 mS; 0.0-199.9 mS).

All new calibration data will over-ride existing stored calibration data for each measuring range you calibrate.

Calibrating for conductivity:

For CON 400 and CON 410 meters only

1. If necessary, press the MODE key to select conductivity mode.

See figure **A**

2. Rinse the probe thoroughly with de-ionized water or a rinse solution, then rinse with a small amount of calibration standard.
3. Dip the probe into the calibration standard. Immerse the probe tip beyond the upper steel band. Stir the probe gently to create a homogeneous sample. Allow time for the reading to stabilize.

See figure **B**

4. Press CAL/MEAS to enter conductivity calibration mode. The CAL indicator will appear in the upper right corner of the display.
5. Press the MI/▲ or MR/▼ to change the value on the primary display to match the value of the calibration standard.

See figure **C**

6. Press ENTER to confirm the calibration value. The meter returns to the MEAS (measurement) mode.
7. Repeat steps 1-6 for other measuring ranges.

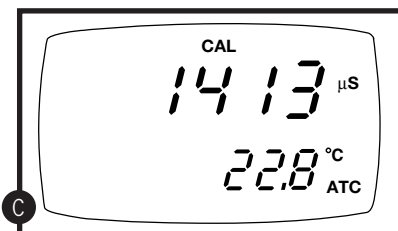
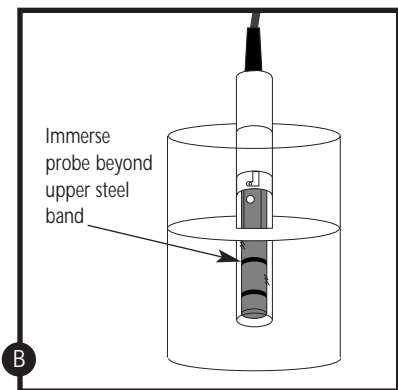
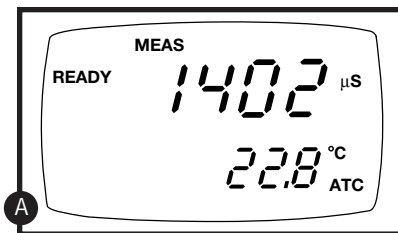

Notes

When entering calibration mode, the meter will display the factory default value. If the meter was previously calibrated, the display may “jump” to the factory default value when switching from measurement to calibration mode.

To exit from Conductivity Calibration mode without confirming calibration, DO NOT press ENTER in step 6. Press CAL/MEAS instead. This will retain the meter's old calibration data in the measuring range of the calibration.

You can offset the conductivity reading up to $\pm 20\%$ from the default setting. If your measured value differs by more than $\pm 20\%$, clean or replace probe as needed.

OAKTON offers a wide selection of high-quality calibration standards. See page 46 for more information.

4.4 TDS calibration

4.4.1 Calibrating for TDS directly:

For TDS 400 and CON 410 meters only

The factory default setting for TDS conversion factor is 0.5. If your solution has a different TDS factor, you can improve calibration accuracy by setting the TDS factor prior to calibration. See page 34 for directions.

1. If necessary, press the MODE key to select TDS mode.

See figure **A**

2. Rinse the probe thoroughly with de-ionized water or a rinse solution, then rinse with a small amount of calibration standard.
3. Dip the probe into the calibration standard. Immerse the probe tip beyond the upper steel band. Stir the probe gently to create a homogeneous sample. Allow time for the reading to stabilize.

See figure **B**

4. Press CAL/MEAS to enter TDS calibration mode. The CAL indicator will appear in the upper right corner of the display.
5. Press the MI/▲ or MR/▼ to change the value on the primary display to match the value of the calibration standard.

See figure **C**

6. Press ENTER to confirm the calibration value. The meter returns to the MEAS (measurement) mode.
7. Repeat steps 1-6 for other measuring ranges.

Notes

To exit from TDS Calibration mode without confirming calibration, DO NOT press ENTER in step 6. Press CAL/MEAS instead. This will retain the meter's old calibration data in the measuring range of the calibration.

You can offset the TDS reading up to $\pm 20\%$ from the default setting. If your measured value differs by more than $\pm 20\%$, clean or replace probe as needed.

OAKTON offers a wide selection of high-quality calibration standards. See page 46 for more information.

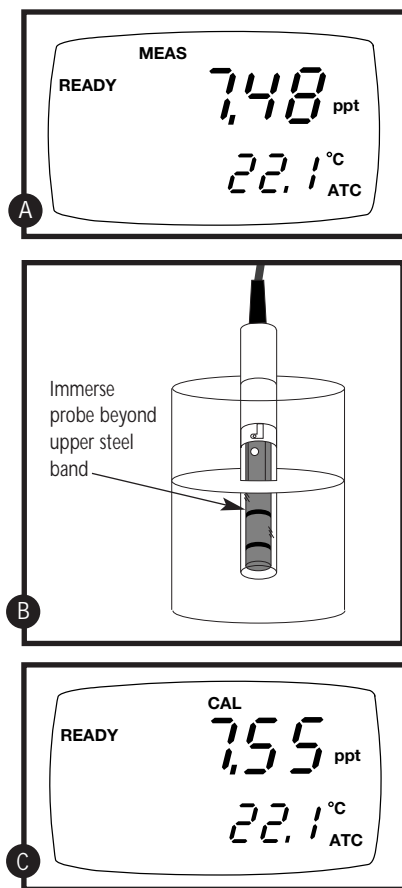

4.4.2 Calibration with Conductivity standard and TDS factor

Use this calibration method for CON 410 meter only

The concentration of salts dissolved in solution increases the conductivity of that solution. This relationship varies from salt to salt and is roughly linear over a given range for a given salt. The TDS conversion factor is the number used by the meter to convert from conductivity to TDS.

Instead of calibrating for TDS directly (described in section 4.4.1), you can calibrate the CON 410 meter by:

1. calibrating to conductivity standards (as described on pages 12-13) and then
2. entering the appropriate TDS conversion factor into the meter.

To determine the conductivity to TDS conversion factor for your solution:

- Addendum 2 on page 48 lists some commonly used conversion factors.
- Addendum 3 on page 49 describes how to calculate the TDS conversion factor for other solutions.

Enter the TDS conversion factor into your meter as follows:

From measurement mode

1. Press Setup key to enter Set Up mode.
2. Press the ▲ and ▼ keys to scroll through subgroups until you view parameter P4.0.

See figure **A**

3. Press the ENTER key five times to select parameter 4.4. The upper display shows "tdS" and the lower display shows "P4.4".

See figure **B**

4. Press the ENTER key again. The upper display shows a value and the lower display shows "tdS".

See figure **C**

5. Calculate the TDS factor of your solution. See Addendum 3 on page 49 for information on how to calculate the TDS factor.
6. Press the ▲ and ▼ keys to select your calculated TDS conversion factor.
7. Press the ENTER key to confirm selection and to return to the subgroup menu. Press the CAL/MEAS key to return to measurement mode.

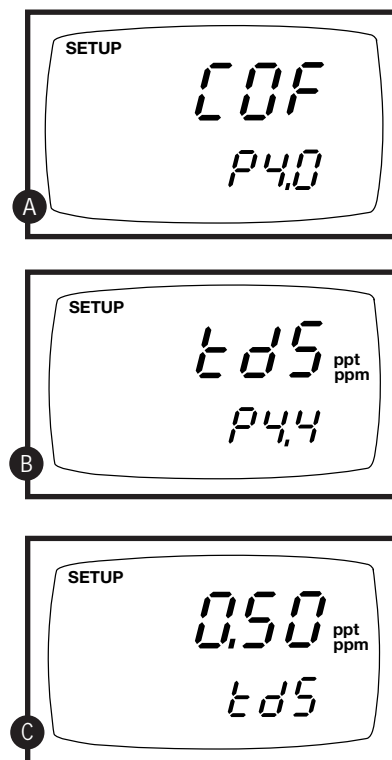

4.5 Temperature Calibration

Your probe features a built-in temperature sensor. The temperature sensor is factory calibrated. Calibrate your sensor only if you suspect temperature errors that may have occurred over a long period of time or if you have a replacement probe.

Temperature calibration

1. Make sure the cell is attached to the 6-pin connector. The ATC annunciator will appear at the right-hand side of the LCD*.
2. Switch the meter on. Press the MODE key to select conductivity mode.
3. Press the CAL/MEAS key to enter conductivity or TDS calibration mode. The CAL indicator appears above the primary display.

See figure **A**

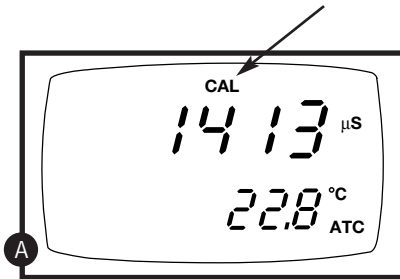

4. While in conductivity or TDS calibration mode, press the MODE key to enter temperature calibration mode. The primary display shows the current temperature reading and the secondary display shows the factory default temperature value.

See figure **B**



5. Dip the cell into a solution of known temperature (i.e. a temperature bath). Allow time for the built-in temperature sensor to stabilize.

6. Scroll with the ▼ and ▲ keys to set the correct temperature value (i.e. the temperature of the temperature bath). You can adjust the reading in increments of 0.1°C.

See figure **C**

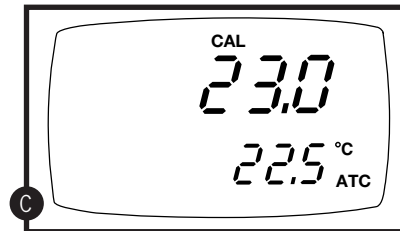

7. Once you have selected the correct temperature, press the ENTER key.
8. Press the CAL/MEAS key to return to conductivity or TDS measurement mode.

Notes

- You can offset the temperature reading up to $\pm 5^{\circ}\text{C}$ from the original reading.
- To exit this program without confirming the temperature calibration value, DO NOT press ENTER in step 7. Press CAL/MEAS instead.

*If the ATC indicator does not light, see Program P4.3, on page 33 to switch it on.

5. Measurement

This meter is capable of taking measurements with automatic or manual temperature compensation. Factory default is ATC on.

5.1 Automatic Temperature Compensation

For automatic temperature compensation (ATC) simply plug the conductivity/TDS probe into the meter (see page 9 for directions). The ATC indicator will light on the LCD.

See figure **A**

Notes

If the ATC indicator does not light, manual temperature compensation may be selected in the meter's Set Up mode. See Program P4.3 on page 33 for directions on selecting Automatic Temperature Compensation.

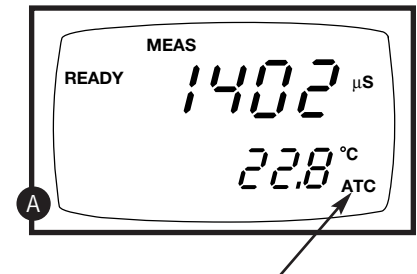

5.2 Manual Temperature Compensation

IMPORTANT: For manual compensation, you must deactivate the temperature probe.

5.2.1 Selecting Manual Temperature Compensation

Select between Automatic Temperature Compensation (ATC) and Manual Temperature Compensation in the Set Up Program P4.3. Meter default is ATC on.

From measurement mode

1. Press Setup key to enter Set Up mode.
2. Press the ▲ and ▼ keys to scroll through subgroups until you view parameter P4.0.

See figure **A**

3. Press the ENTER key three times to select parameter 4.3. The upper display shows “ATC” and the lower display shows “P4.3”.

See figure **B**

4. Press the ENTER key again. The upper display shows “ATC” and the lower display shows “YES” or “NO”.

See figure **C**

5. Press the ▲ and ▼ keys to select the Automatic Temperature Compensation feature on or off.
 - YES = ATC on
 - NO = ATC off
6. Press the ENTER key to confirm selection and to return to the subgroup menu. Press the CAL/MEAS key to return to measurement mode.

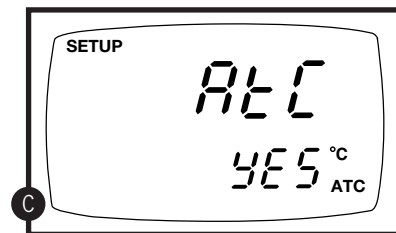
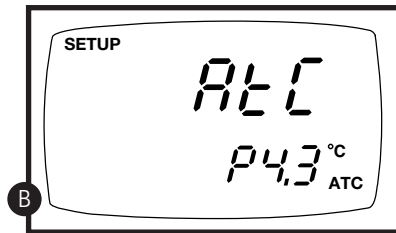
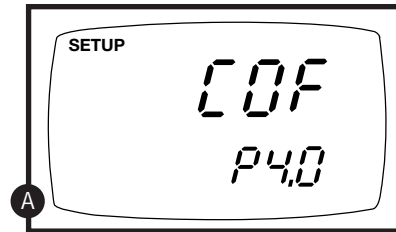

5.2.2 Setting a manual temperature compensation value

To use manual temperature compensation, you need to enter the temperature value of your process into the meter. This is the value at which readings will manually temperature compensate. You can select any temperature between 0 and 100°C (32 and 212°F). Default value is 25°C.

To select a manual temperature compensation value:

1. Switch the meter on. Press the MODE key to select measurement mode.
2. If necessary, select ATC off as described in section 5.2.1 on page 18. The ATC indicator will not appear on the display.
3. Press the CAL/MEAS key to enter conductivity or TDS calibration mode. The CAL indicator will appear above the primary display.

See figure **D**

4. While in conductivity or TDS calibration mode, press the MODE key to enter temperature calibration mode. The primary display shows the current temperature setting and the secondary display shows the default value 25°C (77°F).

See figure **E**

5. Check the temperature of your sample using an accurate thermometer.
6. Press the ▲ or ▼ keys to offset the temperature to the measured value from step 5.

See figure **F**

7. Press ENTER to confirm the selected temperature and to return to the conductivity or TDS measurement mode.

The meter will now compensate conductivity or TDS readings for the manually set temperature.

Notes

To exit this program without confirming the manual temperature compensation value, DO NOT press ENTER in step 7. Press CAL/MEAS instead.

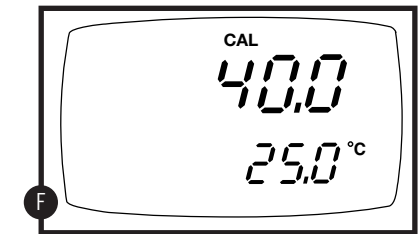
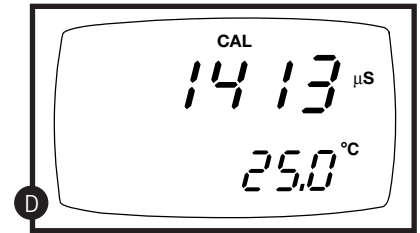

5.3 Taking Measurements

To take readings:

1. Rinse the probe with deionized or distilled water before use to remove any impurities adhering to the probe body. Shake or air dry. To avoid contamination or dilution of your sample, rinse probe with a small volume of your sample liquid.
2. Press ON to switch on meter. The MEAS annunciator appears on the top center of the LCD.

See figure **A**

3. Dip the probe into the sample.

When dipping the probe into the sample, the tip of the probe must be immersed above the second steel band. Stir the probe gently in the sample to create a homogenous sample.

4. Allow time for the reading to stabilize. Note the reading on the display.
5. CON 410 meter only: Press the MODE key to toggle between conductivity and TDS readings.

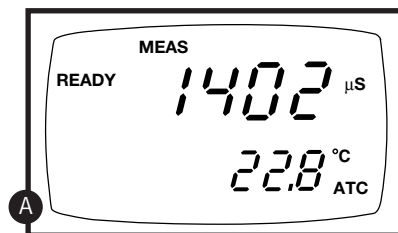

Taking measurements with READY indicator selected on

If the READY indicator has been activated, the READY annunciator lights when the reading is stable. Switch the READY indicator on or off in Set up program P4.1—see page 31 for directions.

Taking measurements with the auto endpoint feature selected on

When a reading is stable for more than 5 seconds, the auto endpoint feature will automatically “hold” the reading. The “hold” indicator appears on the left side of the display. Press the HOLD key to release the reading. Switch the Auto endpoint feature on or off in Set up program P4.1—see page 31 for directions.

5.4 Using Manual Ranging Function

When shipped from the factory, your meter automatically selects the range in which your readings appear. The manual ranging function lets you select the specific range you want to work in:

CON 400 and CON 410 meters:

1. 0.00-19.99 μ S;
2. 0.0-199.9 μ S;
3. 0-1999 μ S;
4. 0.00-19.99 mS;
5. 0.0-199.9 mS.

TDS 400 and CON 410 meters:

1. 0.00-9.99 ppm;
2. 10.0-99.9 ppm;
3. 100-999 ppm;
4. 1.00-9.99 ppt;
5. 10.0-200 ppt.

1. To select the desired measuring range, press the RANGE key while in Measurement mode. The first range will appear on the display. The “MEAS” indicator blinks.

See figure **A**

2. Press the RANGE key again (if needed) until desired range is selected.
3. To reselect the Auto-ranging function, repeatedly press the RANGE key until the “MEAS” indicator appears without blinking.

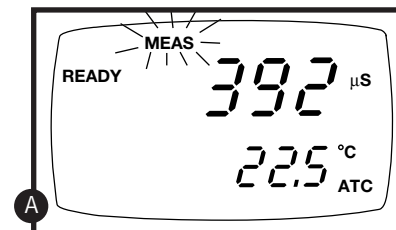

Conductivity range 3 (0 to 1999 μ S)
displayed above

Notes

If the value of the solution you are measuring is higher than the range selected “Or” will appear on the primary display. Press RANGE until the correct range is selected.

See figure **B**

The meter resets to the Auto-ranging function once it is turned off. You will have reset the manual ranging function each time you turn the meter off.

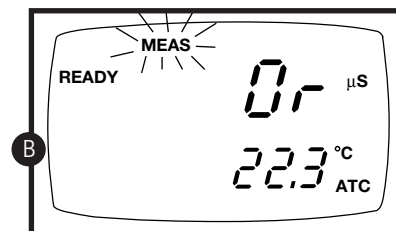

5.5 Hold Function

This feature lets you freeze the display for a delayed observation. HOLD can be used any time when in MEAS mode.

1. To hold a measurement, press the HOLD key while in measurement mode. "HOLD" will appear on the display.

See figure **A**

2. To release the held value, press HOLD again. Continue to take measurements.

NOTE: This meter shuts off automatically after 30 minutes of nonuse. If the meter is shut off either automatically or manually, the HOLD value will be lost. For longer storage, use the memory functions (see pages 23-24).

NOTE: Your meter has an auto endpoint feature. When this feature is switched on, and when a reading is stable for more than 5 seconds, the display will automatically "hold" the reading. The "hold" indicator appears. Press the HOLD key to release the reading. To switch on or off the auto endpoint feature, see Set up program P4.1 on page 31.

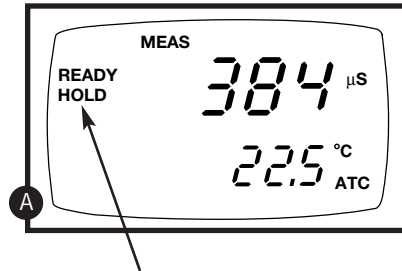

6. Memory and data input functions

6.1 Memory Input

Your meter stores up to 50 sets of data. Data sets include conductivity, temperature, date, and time.

To store a reading:

1. During any measurement function (MEAS), press the MI key to input any data into the memory
2. MEM, "Sto" and memory number will flash. The meter then returns to measurement mode.

See figure **A**

NOTE: If the memory is full, the first value stored will be erased to create space for the new value.

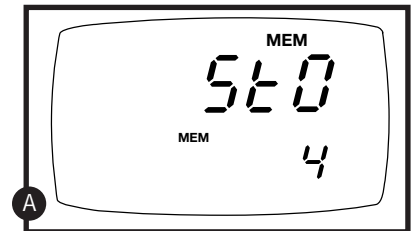

6.2 Memory Recall

This function recalls the previous readings stored in the memory. You can only access MR from the MEASUREMENT mode. Memory recall is in “Last In First Out” order.

To recall readings:

1. Press the MR key once to retrieve the last reading stored. The memory location screen—MEM, “Loc” and the memory number—will flash on the display.

See figure **B**

2. Press the ENTER key to recall the reading stored under that memory number.

See figure **C**

3. Press the ENTER key again to view the date and time the reading was taken.

See figure **D**

4. Press the ENTER key again to return to the “memory location” screen. The display automatically moves to the next memory location screen.

See figure **E**

5. If necessary, press the ▲ key to select the next “memory location” screen; press the ▼ key to select the previous “memory location” screen.
6. Repeat steps 2-5 to review additional stored data sets.
7. To exit Memory Recall, press the MEAS key to return to the Measurement mode.

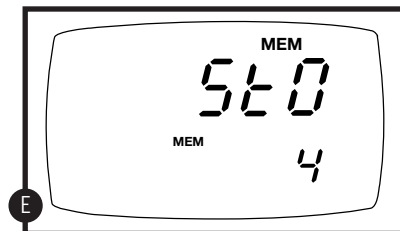
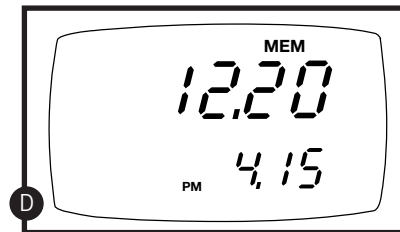
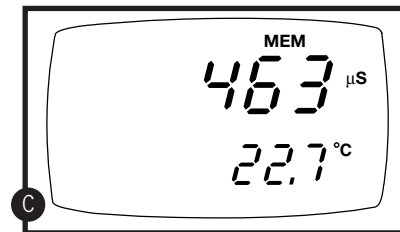
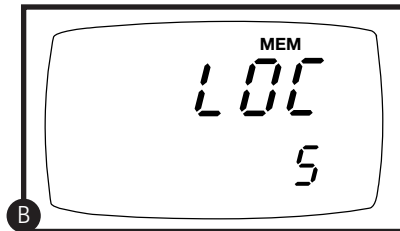

Notes

Readings stored in memory are retained even if the unit is turned off. To erase all readings stored in memory, use the SETUP mode P1.0 on page 28.

7. Advanced set up mode

The advanced set up mode lets you customize your meter's preferences and defaults. Your waterproof meter features different sub groups that organize all set-up parameters.

The sub groups are:

1. P1.0: Memory clear (CLR)
2. P2.0: Viewing calibration data (CAL)
3. P3.0: Viewing probe data (ELE)
4. P4.0: Unit configuration (COF)
5. P5.0: Temperature (tPr)
6. P6.0: Selecting cell constant (CEL)
7. P7.0: Setting clock (CLO)
8. P8.0: Reset to factory defaults (rSt)

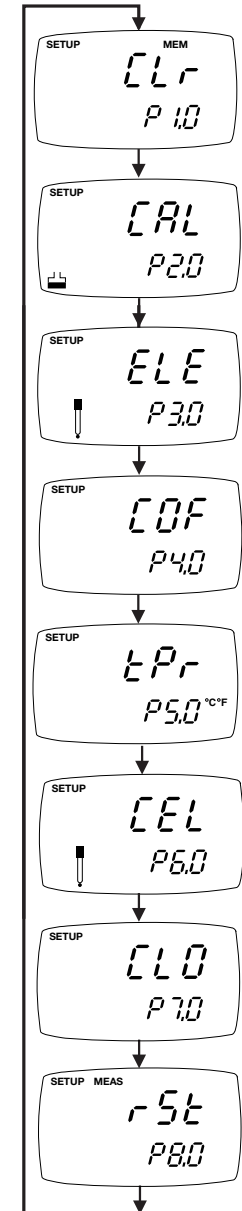

7.1 Set-up mode overview

Press the SETUP key to enter Set up mode.

Press the ▲ and ▼ keys to scroll between sub groups.

Press the ENTER key to enter a particular parameter.

See Addendum 5 on page 51 for a table of meter factory default settings.

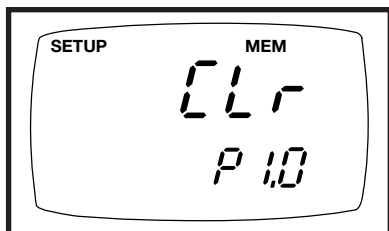

Instructions on page 28

P1.0: Memory clear

- P1.0 Clear all stored readings

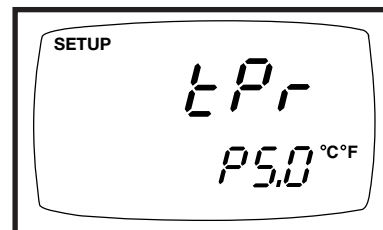

Instructions on page 35-36

P5.0: Temperature

- P5.1: Adjusting temperature coefficient
- P5.2: Adjusting normalization temperature

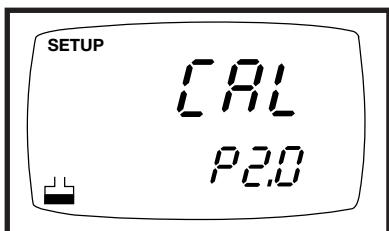

Instructions on page 29

P2.0: Viewing previous calibration data

- P2.1: First range calibration point
- P2.2: Second range calibration point
- P2.3: Third range calibration point
- P2.4: Fourth range calibration point
- P2.5: Fifth range calibration point

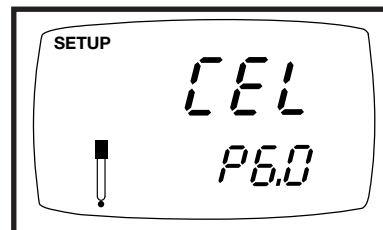

Instructions on page 37

P6.0: Selecting cell constant

- P6.1: Selecting cell constant:
K = 1.0, 10, or 0.1

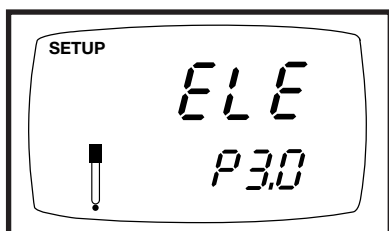

Instructions on page 30

P3.0: Viewing probe data

- P3.1: Effective cell constant for first range
- P3.2: Effective cell constant for second range
- P3.3: Effective cell constant for third range
- P3.4: Effective cell constant for fourth range
- P3.4: Effective cell constant for fifth range

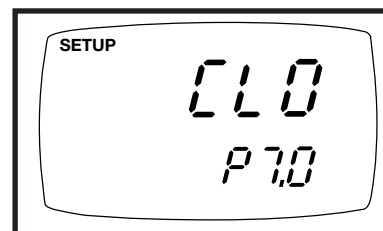

Instructions on page 38-39

P7.0: Setting clock

- Setting year
- Setting date (month/day)
- Setting time (hour/minute/second)

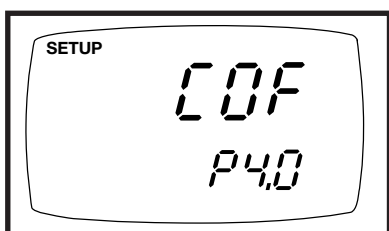

Instructions on page 31-34

P4.0: Unit configuration

- P4.1: Ready indicator and auto endpoint function—select on or off
- P4.2: Select °C or °F
- P4.3 Select Automatic or Manual Temperature Compensation
- P4.4 Setting TDS conversion factor (TDS 400 and CON 410 meters only)

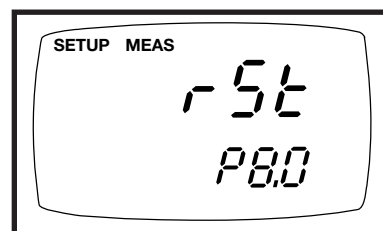

Instructions on page 40

P8.0: Reset to factory defaults

P8.0: reset meter to factory defaults

7.2 P1.0: Memory Clear

Use this parameter to clear all memory values when you need to store a new series of values. This lets you avoid confusing the old values with the new ones. NO is the default setting.

NOTE: Selecting YES will wipe out all memory.

From measurement mode:

1. Press the Set up key to enter Set Up mode.
2. Press the ▲ and ▼ keys to scroll through subgroups until you view parameter P1.0.

See figure A

3. Press the ENTER key to enter parameter P1.0.

4. Press the ▲ and ▼ keys to toggle between NO and YES.

- NO retains current memory
- YES clears all memory

See figure B

5. Press the ENTER key to confirm selection and return to the subgroup menu. Press the CAL/MEAS key to return to measurement mode.

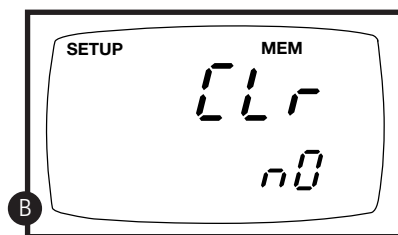
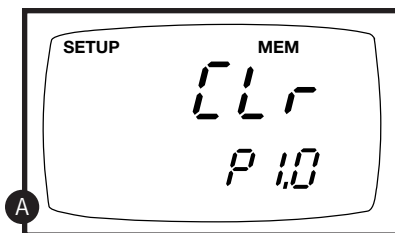

7.3 P2.0: Viewing calibration data

This mode lets you recall previous calibration data, which helps you know when to recalibrate your meter. This is a “view only” mode.

From measurement mode:

1. Press the Set up key to enter Set Up mode.

See figure A

2. Press the ▲ and ▼ keys to scroll through subgroups until you view parameter P2.0.

3. Press the ENTER key repeatedly to view previous calibration data. The meter will first display the calibration point, and then display the date and time of calibration to help you comply with GLP standards.

See figures B and C

4. When you have scrolled through all calibration data, you will automatically return to the subgroup menu. Press the CAL/MEAS key to return to measurement mode.

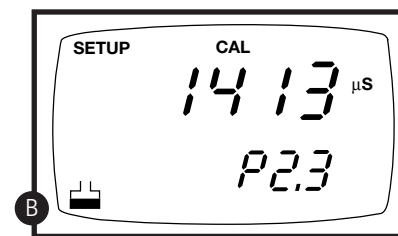
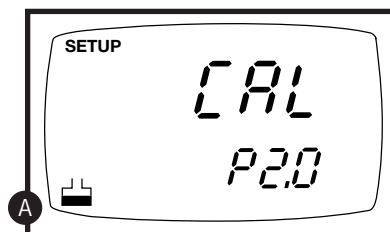

Calibration data

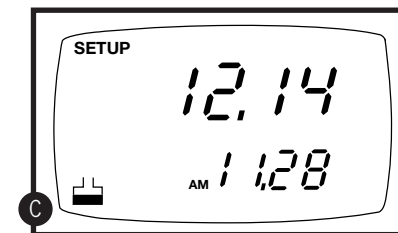

date/time

Notes

If there is no previous calibration data at a particular point, the primary display will show “----”.

CON 410 meter only: If you entered Set Up mode from Conductivity measurement mode, calibration data will be in μS or mS . If you entered Set Up mode from TDS measurement mode, calibration data will be in ppm or ppt.

7.4 P3.0: Viewing probe data

Program 3 has five "view only" options that let you check your probe's parameters for diagnostic purposes. These options show you the effective cell constant for each range. The cell constant is adjusted according to your calibration.

From measurement mode:

1. Press the Set up key to enter Set Up mode.

See figure **A**

2. Press the ▲ and ▼ keys to scroll through subgroups until you view parameter P3.0.
3. Press the ENTER key repeatedly to view the effective cell constant for each range.

See figure **B**

4. When you have scrolled through all probe data, you will automatically return to the subgroup menu. Press the CAL/MEAS key to return to measurement mode.

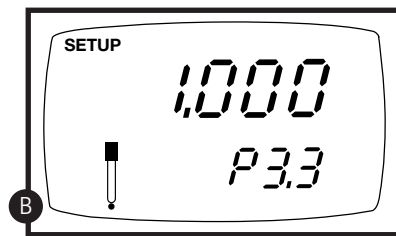
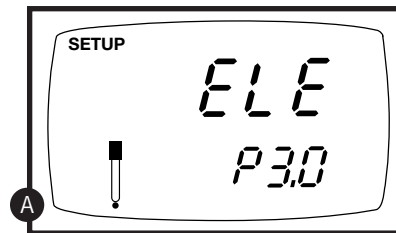

Notes

Cell constants will degrade with time and usage. You can use this feature to alert you to the need for a new probe prior to total failure.

7.5 P4.0: Unit configuration

P4.1: READY indicator and auto endpoint function

Program P4.1 lets you select "READY indicator on" to indicate when your measurement is stable, or select "READY indicator off" for faster meter response.

Program P4.1 also lets you switch the Auto endpoint function on or off. Select auto endpoint on to "hold" your measurement when it is stable for more than 5 seconds. The display automatically freezes, and the HOLD indicator appears on the left side of the display. Press the HOLD key to release the display and access other functions. Select auto endpoint off to deactivate this feature.

From measurement mode

1. Press Setup key to enter Set Up mode.
2. Press the ▲ and ▼ keys to scroll through subgroups until you view parameter P4.0.

See figure **A**

3. Press the ENTER key to select parameter 4.1.

See figure **B**

4. Press the ▲ and ▼ keys to select the configuration you require.
 - OFF switches the READY indicator off.
 - ON switches the READY indicator on.
 - ON and HOLD together switches the auto endpoint feature on.
5. Press the ENTER key to confirm selection and to proceed to step 4 of P.4.2. Press the CAL/MEAS key to return to measurement mode.

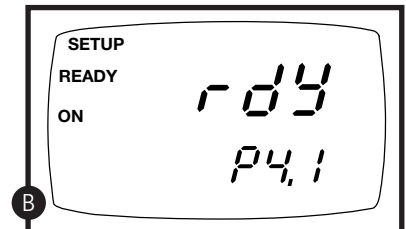
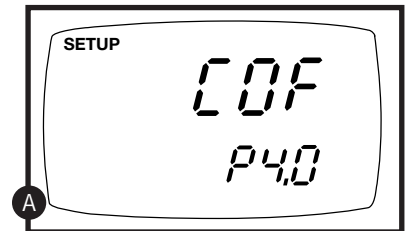

Notes

Meter default is set for Ready indicator on, and auto endpoint function off.

P4.2 Selecting °C or °F

You can select between °C and °F units for temperature readings. Meter default is °C.

From measurement mode

1. Press Setup key to enter Set Up mode.
2. Press the ▲ and ▼ keys to scroll through subgroups until you view parameter P4.0.

See figure C

3. Press the ENTER key two times to select parameter 4.2.

See figure D

4. Press the ▲ and ▼ keys to toggle between °C and °F.
5. Press the ENTER key to confirm selection and to proceed to step 3 of P4.3. Press the CAL/MEAS key twice to return to measurement mode.

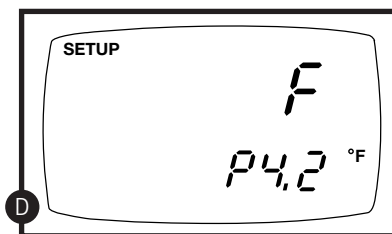
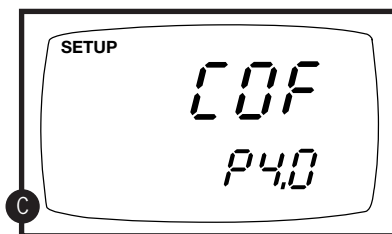

P4.3 Selecting Automatic or Manual Temperature Compensation

This feature lets you select between Automatic Temperature Compensation (ATC) and Manual Temperature Compensation. Meter default is ATC.

From measurement mode

1. Press Setup key to enter Set Up mode.
2. Press the ▲ and ▼ keys to scroll through subgroups until you view parameter P4.0.

See figure E

3. Press the ENTER key three times to select parameter 4.3. The upper display shows "ATC" and the lower display shows "P4.3".

See figure F

4. Press the ENTER key again. The upper display shows "ATC" and the lower display shows "YES" or "NO".

See figure G

5. Press the ▲ and ▼ keys to select the Automatic Temperature Compensation on or off.
 - YES = ATC on
 - NO = ATC off
6. Press the ENTER key to confirm selection and to return to the subgroup menu. Press the CAL/MEAS key to return to measurement mode.

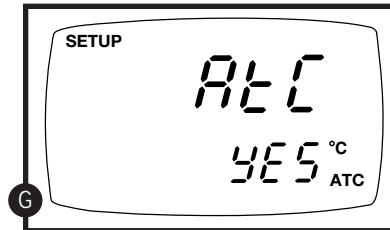
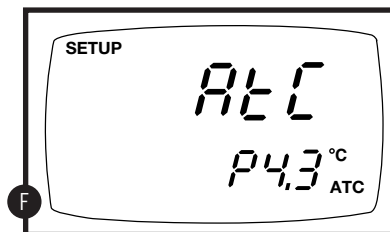
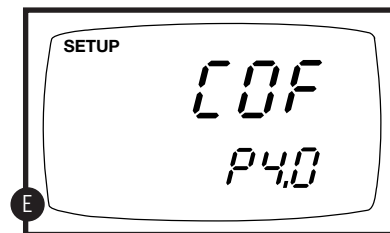

P4.4 Setting the TDS factor

For TDS 400 and CON 410 meters only

The concentration of salts dissolved in solution increases the conductivity of that solution. This relationship varies from salt to salt and is roughly linear over a given range for a given salt. The TDS conversion factor is the number used by the meter to convert from conductivity to TDS.

To determine the conductivity to TDS conversion factor for your solution:

- Addendum 2 on page 48 lists some commonly used conversion factors.
- Addendum 3 on page 49 describes how to calculate the TDS conversion factor for other solutions.

You can set the TDS conversion factor between 0.4 and 1.0; meter default is 0.5.

From measurement mode

1. Press Setup key to enter Set Up mode.
2. Press the ▲ and ▼ keys to scroll through subgroups until you view parameter P4.0.

See figure H

3. Press the ENTER key five times to select parameter 4.4. The upper display shows "tdS" and the lower display shows "P4.4".

See figure I

4. Press the ENTER key again. The upper display shows a value and the lower display shows "tdS".

See figure J

5. Calculate the TDS factor of your solution. See Addendum 3 on page 49 for information on how to calculate the TDS factor.
6. Press the ▲ and ▼ keys to select your calculated TDS conversion factor.
7. Press the ENTER key to confirm selection and to return to the subgroup menu. Press the CAL/MEAS key to return to measurement mode.

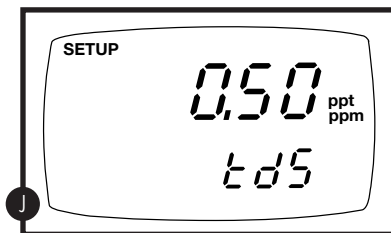
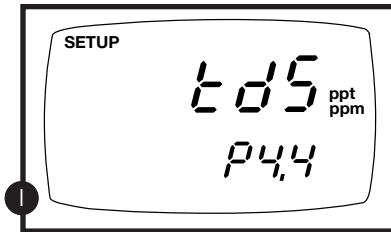
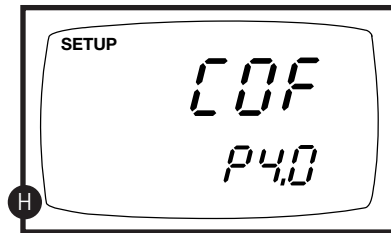

7.6 P5.0: Temperature

P5.1 Adjusting the temperature coefficient

The temperature coefficient is the amount of change in conductivity per degree of temperature; it is expressed in percent per °C or °F. Entering the exact temperature coefficient of your solution lets you accurately compensate temperature for almost any solution*. You can adjust 0.0 to 10.0% per °C or °F. Meter default is 2.1% per °C or °F.

From measurement mode

1. Press Setup key to enter Set Up mode.
2. Press the ▲ and ▼ keys to scroll through subgroups until you view parameter P5.0.

See figure A

3. Press the ENTER key to select parameter 5.1. The display shows "T.CO" on the upper display.

See figure B

4. Press the ENTER key again. The upper display shows the temperature coefficient and the lower display shows "T.CO".

See figure C

5. Press the ▲ and ▼ keys to select the temperature coefficient of your solution.
6. Press the ENTER key to confirm selection and to proceed to step 3 of P.5.2. Press the CAL/MEAS key twice to return to measurement mode.

Notes

* If you do not know the temperature coefficient of your solution you can determine the correct value using the formula in Addendum 3 "Calculating Temperature Coefficients" on page 50.

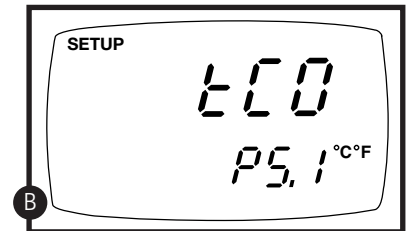
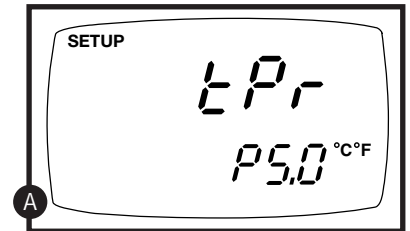

P5.2 Adjusting the normalization temperature

Your meter will normalize its conductivity measurements to a standard temperature that you can select. You can adjust the normalization temperature from 15 to 30°C (59 to 86°F). Meter default is 25°C (77°F).

From measurement mode

1. Press Setup key to enter Set Up mode.
2. Press the ▲ and ▼ keys to scroll through subgroups until you view parameter P5.0.

See figure **D**

3. Press the ENTER key three times to select parameter 5.2. The display shows “t.nr” on the upper display.

See figure **E**

4. Press the ENTER key again. The upper display shows the normalization temperature and the lower display shows “t.nr”.

See figure **F**

5. Press the ▲ and ▼ keys to select the normalization temperature.
6. Press the ENTER key to confirm selection and to return to the subgroup menu. Press the CAL/MEAS key to return to measurement mode.

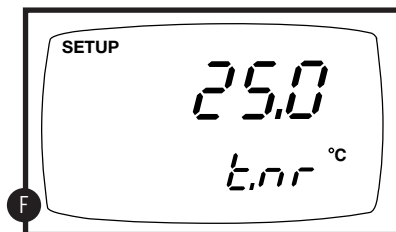
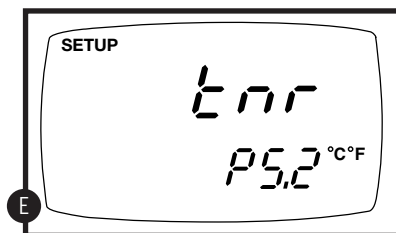
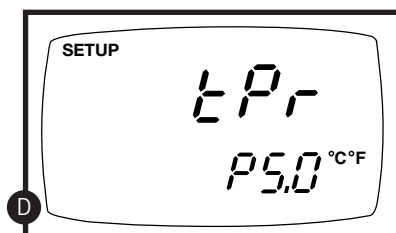

7.7 P6.0: Selecting the cell constant

Your meter lets you select a cell constant of K = 1.0, 10, or 0.1.

- Use a cell of K = 1.0 for midrange measurements
- Use a cell of K = 10 for high range measurements (above 20 mS or 10 ppt)
- Use a cell of K = 0.1 for low range measurements (below 20 µS or 10 ppm).

The cell included with your meter has a cell constant of K = 1.0. Order cells with a cell constant of K = 10 or 0.1 on page 45.

From measurement mode

1. Press Setup key to enter Set Up mode.
2. Press the ▲ and ▼ keys to scroll through subgroups until you view parameter P6.0.

See figure **A**

3. Press the ENTER key to select parameter 6.1.

See figure **B**

4. Press the ▲ and ▼ keys to select the between K = 1.0, 0.1, or 10.
5. Press the ENTER key to confirm selection and to return to the subgroup menu. Press the CAL/MEAS key to return to measurement mode.

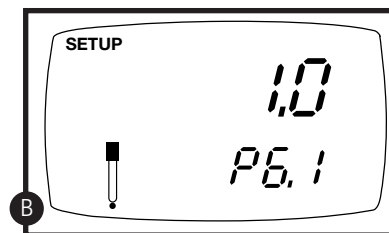
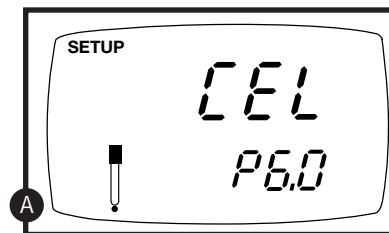

Notes

When using a cell of K = 0.1, the lowest measuring range will be:

- 0 to 1.999 µS (0 to 0.999 ppm).

The 0 to 199.9 mS (10 to 200 ppt) range will not be accessible.

When using a cell of K = 10, the highest measuring range will be:

- 0 to 1999 mS (100 to 2000 ppt).

The 0 to 19.99 µS (0.00 to 9.99 ppm) range will not be accessible.

7.8 P7.0: Setting the clock

Your meter features a real-time calendar and clock. This helps you meet GLP (Good Laboratory Practice) standards.

From measurement mode

1. Press Setup key to enter Set Up mode.
2. Press the ▲ and ▼ keys to scroll through subgroups until you view parameter P7.0.

See figure A

3. Press the ENTER key to enter parameter P7.0. The meter lets you select the century: “19-” or “20-”. The century digits will flash.

See figure B

4. Press the ▲ and ▼ keys to toggle to the correct century.

5. Press the ENTER key to confirm the century and move to “year” selection. The “year” digits will flash.

See figure C

6. Press the ▲ and ▼ keys to toggle to the correct year.

7. Press the ENTER key to confirm the year and move to “month” selection. The “month” digits will flash.

See figure D

8. Press the ▲ and ▼ keys to toggle to the correct month.

9. Press the ENTER key to confirm the month and move to “date” selection. The “date” digits will flash.

See figure E

10. Press the ▲ and ▼ keys to toggle to the correct date.

continued on next page

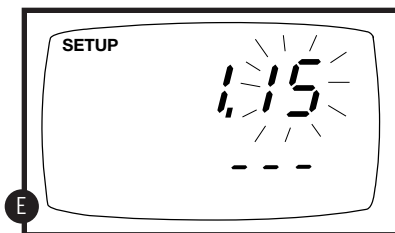
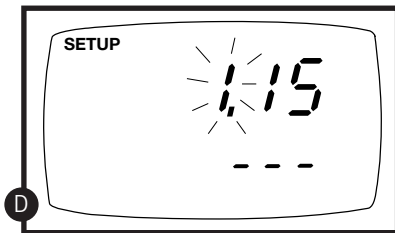
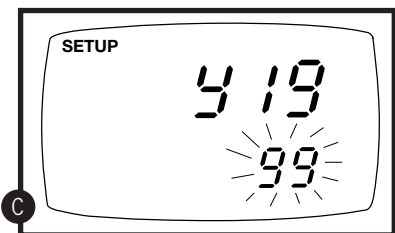
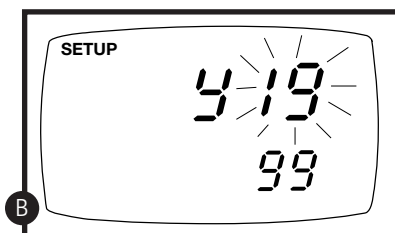
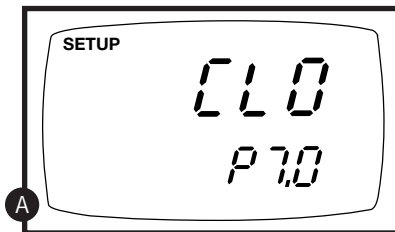

11. Press the ENTER key to confirm the date and move to “hour” selection. The “hour” digits will flash.

See figure F

12. Press the ▲ and ▼ keys to toggle to the correct hour. Note the “AM” and “PM” indicator on the lower portion of the display.

13. Press the ENTER key to confirm the hour and move to “minute” selection. The “minute” digits will flash.

See figure G

14. Press the ▲ and ▼ keys to toggle to the correct minutes.

15. Press the ENTER key to confirm the minutes and move to “second” selection. The “second” digits will flash.

See figure H

16. Press the ▲ and ▼ keys to toggle to the correct seconds.

17. Press the ENTER key to confirm the seconds and return to “century” selection.

18. Press the CAL/MEAS key to return to the subgroup menu. Press the CAL/MEAS key again to return to measurement mode.

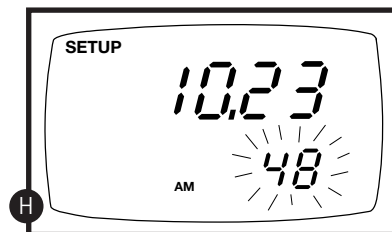
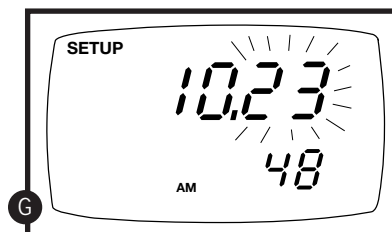
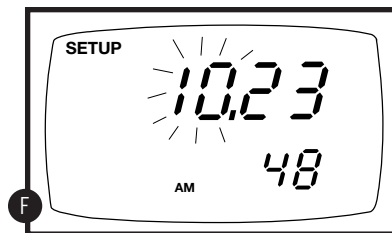

Notes

Press the CAL/MEAS key at any point while setting the time to return to the subgroup menu.

7.9 P8.0: Resetting to factory default settings

Program 8.0 lets you reset all parameters to factory default settings. This clears all calibration data, memory, and any other setup functions you might have changed. It does not clear clock settings.

From measurement mode

1. Press Setup key to enter Set Up mode.
2. Press the ▲ and ▼ keys to scroll through subgroups until you view parameter P8.0.

See figure A

3. Press the ENTER key to enter parameter P8.0.

See figure B

4. Press the ▲ and ▼ keys to toggle between NO and YES.
 - NO retains current settings
 - YES resets to factory default settings
5. Press the ENTER key to confirm selection and to return to the subgroup menu. Press the CAL/MEAS key to return to measurement mode.

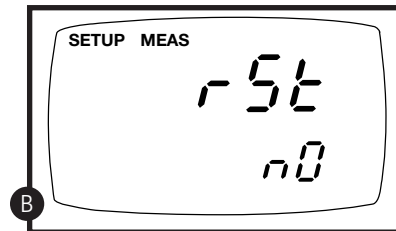
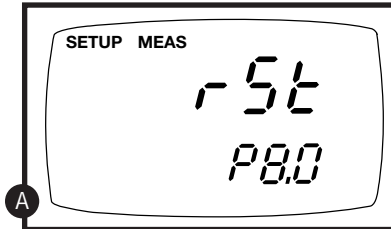

Notes

See Addendum 5 on page 51 for a table of factory default settings.

8. Probe Care and Maintenance

Keep the conductivity probe clean. Rinse the probe twice, and gently swirl it while you take readings. For best accuracy, soak a dry probe for at least 5 to 10 minutes or longer before calibration. Rinse the probe with deionized or tap water before storing. Never scratch the platinum portions with a hard substance. Do not strike the probe against any hard surface.

Do not make continuous contact with your solutions. Readings will rise over a period of time while you soak your probe.

Do not immerse the probe in oily solutions. Clean the electrode thoroughly by stirring it in a mild detergent bath or isopropyl alcohol. Wipe the probe with a soft tissue paper. Rinse thoroughly in tap water and then in deionized water. Recalibrate the meter after cleaning the probe.

The model WD-35608-50 probe (included with your meter) features a removable probe guard to make cleaning easy.

To remove probe guard:

1. Grip yellow probe guard and twist clockwise. The locking notch will release.
2. Slide probe guard off end of probe.

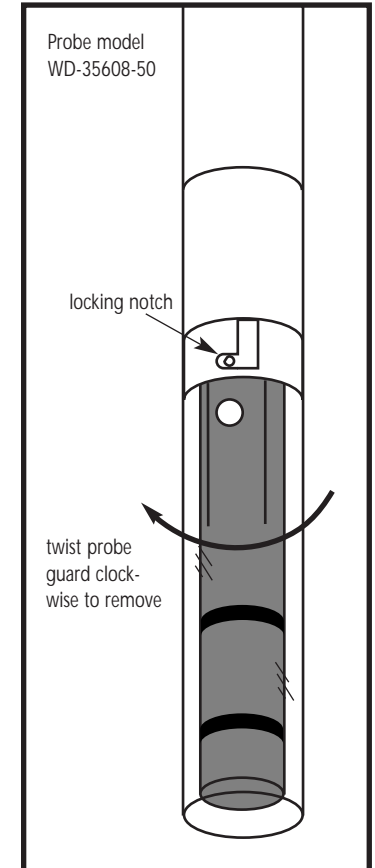

9. Troubleshooting

Problem	Cause	Solution
Power on but no display	a) Batteries not in place. b) Batteries not in correct polarity (+ and -). c) Weak batteries.	a) Check that batteries are in place and making good contact. b) Reinsert batteries with correct polarity. c) Replace batteries or attach optional AC adapter.
Unstable readings	a) Air bubbles in probe. b) Dirty probe. c) Probe not deep enough in sample. d) External noise pickup or induction caused by nearby electric motor. e) Broken probe.	a) Tap probe to remove bubbles. b) Clean the probe and recalibrate. c) Make sure sample entirely covers the probe sensors. d) Move or switch off interfering motor. e) Replace probe. See page 45.
Slow response	a) Dirty/Oily probe.	a) Clean probe. See "Probe Care & Maintenance", page 41.

10. Error Messages

LCD Display	Indicates	Cause	Solution
Err annunciator	Unrecognized input from keypad	Wrong input in selected mode.	Release key. Select valid operations depending on mode.
CAL & Err annunciators on/ Buffer and electrode indicators blink	Calibration error	Wrong buffer value input at calibration. Dirty probe.	Check your calibration input value, clean probe. See Calibration sections or Probe Maintenance section.
Battery indicator blinks	Low battery level	Need new batteries or battery connection is bad	Clean battery contacts. Replace batteries with fresh ones, noting polarity
Err. 1 (in primary display)	Memory write error	Hardware failure.	Turn meter on and off again. If message persists, return unit*
Err. 2 (in primary display)	Memory checksum error	Hardware failure.	Turn meter on and off again. If message persists, return unit*
Err. 3 (in primary display)	ACD converter error	Hardware failure.	Turn meter on and off again. If message persists, return unit*
Err. 4 (in primary display)	Keypad error	Fault in keypad	Turn meter on and off again. If message persists, return unit*

* See "Warranty" and "Return of Items" on page 52.

If an error message appears in the primary display (the upper row of larger digits), switching off the meter and switching it on again may eliminate the error message.

See figure **A**

If error persists, or the meter shows incorrect values, return the meter.

For a complete diagram of the display, see page 5.

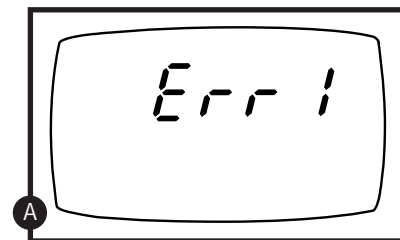

ERR 1 in primary display

11. Specifications

Mode	Conductivity (CON 400 & 410 meters)	TDS (TDS 400 & CON 410 meters)	Temperature
Range (Resolution)	0.00 to 19.99 μ S (0.01 μ S) 0.0 to 199.9 μ S (0.1 μ S) 0 to 1999 μ S (1 μ S) 0.0 to 19.99 mS (0.01 mS) 0.0 to 199.9 mS (0.1 mS)	0.00 to 9.99 ppm (0.01 ppm) 10.0 to 99.9 ppm (0.1 ppm) 100 to 999 ppm (1 ppm) 1.00 to 9.99 ppt (0.01 ppt) 10.0 to 200 ppt (0.1/1 ppt)	0.0 to 100.0°C or 32.0 to 212.0°F (0.1°C or °F)
Accuracy	\pm 1% full scale	\pm 1% full scale	\pm 0.5°C or °F

Cell constant: 1.0, 0.1, or 10 selectable (cell constant of included cell = 1.0)

Temperature compensation: Automatic or manual 0 to 50°C (32 to 122°F)

Temperature coefficient: 0 to 10% per °C or °F

TDS factor: adjustable from 0.4 to 1.0

Operating temperature: 0 to 50°C (32 to 122°F)

Memory: up to 50 points (includes measurement, temperature, date and time)

Real time clock: stamps calibration data and stored data with time and date (month and day)

Power: 4 x 1.5 V AAA batteries (>100 hours)

Dimensions: 7.5"L x 3.5"W x 1.75"H (meter only); 9.2"L x 9.2"W x 2.75"H (boxed)

Weight: 1.0 lb (meter only); 2.0 lbs (boxed complete)

12. Accessories

Replacement meters

WD-35608-00 Replacement waterproof CON 400 meter

WD-35608-05 Replacement waterproof TDS 400 meter

WD-35608-10 Replacement waterproof CON 410 meter

WD-35607-60 Calibration kit. Includes 60 ml each of four calibration solutions: 84 μ S, 447 μ S, 15,000 μ S, and 80 mS; squirt bottle with 120 ml deionized water, and empty 60 ml sample bottle— all in a hard shell carrying case.

Probes

WD-35608-50 Replacement conductivity/TDS cell. Ultem/Stainless Steel with built-in temperature sensor. Cell constant = 1.0

WD-35608-51 Conductivity/TDS cell. Epoxy body with built-in temperature sensor. Cell constant = 10

WD-35608-55 Conductivity/TDS cell. Epoxy body with built-in temperature sensor. Cell constant = 0.1

Continued on next page

OAKTON conductivity/TDS calibration solution bottles

Our solutions come in 1 pint recyclable PE bottles. $\pm 1\%$ accuracy at 25°C. Shpg wt 1.1 lb (510 g).

Model No.	Solution type	TDS calibration values		
		ppm KCl	ppm NaCl	ppm 442
WD-00653-16	84 μS	40.38	38.04	50.50
WD-00653-47	447 μS	225.6	215.5	300.0
WD-00653-18	1413 μS	744.7	702.1	1000
WD-00653-15	1500 μS	757.1	737.1	1050
WD-00653-89	8974 μS	5101	4487	7608
WD-00606-10	12,880 μS	7447	7230	11,367
WD-00653-50	15,000 μS	8759	8532	13,455
WD-00653-32	80 mS	52,168	48,384	79,688

OAKTON conductivity/TDS calibration solution pouches

Each pouch contains 20 ml of fresh, premixed calibration solution—guarantees uncontaminated solution for every use. $\pm 1\%$ accuracy at 25°C. 20 pouches/box. Shpg wt 1.1 lb (510 g).

Model No.	Solution type	Conductivity-to-TDS calibration values		
		ppm KCl	ppm NaCl	ppm 442
WD-35653-10	447 μS	225.6	215.5	300.0
WD-35653-11	1413 μS	744.7	702.1	1000
WD-35613-13	15,000 μS	8759	8532	13,455

WD-35653-00 Deionized rinse water pouches. 20 pouches/box.

To order OAKTON accessories, contact your OAKTON distributor.

13. Addendum 1: Calibration Tips

You only need one calibration for measurement throughout the entire range of the meter. If a range was not calibrated, the meter automatically detects the closest range calibrated and uses that calibration information. However, only the ranges that were calibrated have maximum accuracy.

- If you are measuring in ranges near to or greater than 20 mS (10 ppt), or near to or lower than 100 μS (50 ppm), calibrate the meter at least once a week to get specified $\pm 1\%$ F.S. accuracy.
- If you are measuring in the mid ranges and you washed the probe in deionized water and stored it dry, calibrate the meter at least once a month.

Wet the probe for 10 minutes before calibrating or taking readings to saturate the probe surface and minimize drift. If you make measurements at extreme temperatures, calibrate the meter at least once a week.

You should only use the conductivity/TDS probe specified for these meters. These probes have a built-in temperature sensor. If you use a different probe without a temperature sensor, you must measure the solution temperature separately and manually enter the solution temperature (see manual temperature compensation on pages 18-19).

14. Addendum 2: Conductivity to TDS Conversion Factors

- Factor—the conductivity to ppm TDS conversion factor. Multiply conductivity by this factor to get ppm TDS for the type of TDS reading needed.
- 442—a formulation that most closely represents the conductivity to ppm relationship, on average, for naturally occurring fresh water.
- TDS Your Material—These columns are for you to write in your application-specific conductivity-to-ppm values and conversion factors for future reference.

Factor = actual TDS ÷ Actual Conductivity @ 25°C

Conductivity at 25°C	TDS KCl		TDS NaCl		TDS 442 ²		TDS Your Material ³	
	ppm Value	Factor ¹	ppm Value	Factor ¹	ppm Value	Factor ¹	ppm Value	Factor
84 µS	40.38	0.5048	38.04	0.4755	50.50	0.6563		
447 µS	225.6	0.5047	215.5	0.4822	300.0	0.6712		
1413 µS	744.7	0.5270	702.1	0.4969	1000	0.7078		
1500 µS	757.1	0.5047	737.1	0.4914	1050	0.7000		
8974 µS	5101	0.5685	4487	0.5000	7608	0.8478		
12880 µS	7447	0.5782	7230	0.5613	11,367	0.8825		
15000 µS	8759	0.5839	8532	0.5688	13,455	0.8970		
80 mS	52,168	0.6521	48,384	0.6048	79,688	0.9961		

15. Addendum 3: Calculating TDS Conversion Factors

You can calibrate your meter using TDS calibration standard solutions. The calibration standard only needs to give the TDS value at a standard temperature such as 25°C. To determine the conductivity-to-TDS conversion factor use the following formula:

$$\text{Factor} = \text{Actual TDS} \div \text{Actual Conductivity @ 25}^{\circ}\text{C}$$

Definitions:

Actual TDS: Value from the solution bottle label or as a standard you make using high purity water and precisely weighed salts.

Actual Conductivity: Value measured using a properly calibrated Conductivity/Temperature meter.

Both the Actual TDS and the Actual Conductivity values must be in the same magnitude of units. For example, if the TDS value is in ppm the conductivity value must be in µS; if the TDS value is in ppt the conductivity value must be in mS.

Check your factor by multiplying the conductivity reading by the factor in the above formula. The result should be the TDS value.

16. Addendum 4: Calculating Temperature Coefficients

To determine the temperature coefficient of your sample solution use this formula:

$$TC = 100 \times \frac{C_{T_2} - C_{T_1}}{C_{T_1}(T_2 - 25) - C_{T_2}(T_1 - 25)}$$

TC = Temperature coefficient

C_{T_1} = Conductivity at Temp. 1 C_{T_2} = Conductivity at Temp. 2

T_1 = Temp. 1 T_2 = Temp. 2 25 = 25°C

NOTE: A controlled temperature water bath is ideal for this procedure.

1. Immerse the probe into a sample of your solution and adjust the temperature coefficient to 0% (that is, no compensation) by performing the following:
 - A. From measurement mode, press the SETUP key to enter Setup mode.
 - B. Press the ▼ key until the lower display reads P5.0.
 - C. Press the ENTER key twice. The lower display reads tCO and the upper display shows the temperature coefficient value.
 - D. Press the ▼ key until the upper display shows 0.0.
 - E. Press ENTER key to confirm the value.
 - F. Press CAL/MEAS key twice to return to measurement mode.
2. Wait for 5 minutes. Note T_1 and C_{T_1} (conductivity at T_1).
3. Condition the sample solution and probe to a temperature (T_2) that is about 5°C to 10°C different from T_1 , and note the conductivity reading C_{T_2} .

NOTE: Record your results for future reference. Ideally T_1 and T_2 should bracket your measurement temperature, and should not differ by more than 5°C.

4. Calculate the temperature coefficient of your solution according to the formula shown above.
5. Enter the temperature coefficient you calculated into the meter.
 - A. From measurement mode, press the SETUP key to enter Setup mode.
 - B. Press the ▼ key until the lower display reads P5.0.
 - C. Press the ENTER key twice. The lower display reads tCO and the upper display shows the temperature coefficient value (should be 0, per step 1 above).
 - D. Press the ▲ key until the upper display shows your calculated temperature coefficient.
 - E. Press ENTER key to confirm the value.
 - F. Press CAL/MEAS key twice to return to measurement mode.

The calculated temperature coefficient will now be applied to all the meter readings.

17. Addendum 5: Meter factory default settings

Type	Parameter	Default	Remarks
P1.0	Memory clear	no	Retains current memory
P2.1	Viewing previous calibration data	---	No calibration data for 1st range
P2.2		---	No calibration data for 2nd range
P2.3		---	No calibration data for 3rd range
P2.4		---	No calibration data for 4th range
P2.5		---	No calibration data for 5th range
P3.1	Viewing probe data	1.0	No offset for effective cell constant (1st range)
P3.2		1.0	No offset for effective cell constant (2nd range)
P3.3		1.0	No offset for effective cell constant (3rd range)
P3.4		1.0	No offset for effective cell constant (4th range)
P3.5		1.0	No offset for effective cell constant (5th range)
P4.1	Ready indicator/ auto endpoint	READY/ON	Ready indicator on; auto endpoint off
P4.2	Select °C/°F	°C	Degrees Celsius
P4.3	ATC on or off	ATC on	—
P4.4	TDS factor	0.5	Adjustable from 0.4 to 1.0 (available in TDS 400 and CON 410 meters only)
P5.1	Temp. coefficient	2.1% per °C	Adjustable from 0 to 10%
P5.2	Normalization temperature	25°C	Adjustable from 15 to 30°C
P6.1	Cell constant	1.0	Select from K = 1.0, 0.1 or 10
P8.0	Factory default	no	Retains your current settings

Notes

The P7.0 clock function retains the year and time that you set, even after reverting to factory default settings.